

COMUNE DI CAMPOGALLIANO (MO)

PROGETTO PER LA REALIZZAZIONE DI NUOVI DEPOSITI E RELATIVI UFFICI

ACCORDO OPERATIVO

TAVOLA

Integrazione Impatto acustico

Data: 24/07/20

Scala:

COMMITTENTE

Logistica e Sviluppo s.r.l.

Logistica e sviluppo s.r.l.

Via Strasburgo,31
41011 Campogalliano (MO)

GENERAL CONTRACTOR



GSE Italia s.r.l.

Via G.B. Percolesi, 27
20124 Milano (MI)

PROGETTISTA E DL



ING. FILIPPO SALIS

Via della Moscova, 47 - 20121 Milano
Iscrizione ordine ingegneri Milano: MI 24867 - I - 2961

CO-PROGETTISTA URBANISTICO

Studio Dott. Ing. Grotti Loris

Dott. Ing. Grotti Loris

Via Vignolese n. 1389
41126 San Damaso (MO)

Commessa

1

4

9

3

3

Fase

R

T

Lotto

Disegno

1

0

Rev

A

PROVINCIA DI MODENA
COMUNE DI CAMPOGALLIANO

*PROGETTO PER LA REALIZZAZIONE DI NUOVO DEPOSITO DELLA
DITTA TRASPORTI INTERNAZIONALI TRANSMEC S.P.A.*



Documentazione di Impatto Acustico
(DoImA)
INTEGRAZIONI

Committente

TRASPORTI INTERNAZIONALI
TRANSMEC S.P.A.

Gruppo di lavoro

Dott. Juri ALBERTAZZI
Dott.ssa Francesca RAMETTA
Geom Andrea BARBIERI

Luglio 2020



AIRIS

INGEGNERIA PER L'AMBIENTE

www.airis.it

COMUNE DI CAMPOGALLIANO

PROVINCIA DI MODENA

**PROGETTO PER LA REALIZZAZIONE DI NUOVO DEPOSITO DELLA DITTA
TRASPORTI INTERNAZIONALI TRANSMEC S.P.A.**

Committente	Timbro e Firma del committente
<p>Trasporti Internazionali Transmec s.p.a</p>	
 <p>del Porto, 1 - 40122 Bologna Tel 051/266075 - Fax 266401 e-mail: info@airis.it</p> <p>Dott. Juri ALBERTAZZI* <i>Responsabile di commessa</i></p> <p>Dott.ssa Francesca RAMETTA* Geom. Andrea BARBIERI</p> <p>* tecnico acustico competente, abilitato ai sensi della legge 447/95 e Decreto Legislativo n° 42/2017</p>	

Documentazione d'Impatto Acustico (DOIMA) - INTEGRAZIONI	N. Elaborato Unico
	Scala: Varie

Revisione	Data	Descrizione	Dimensioni	Sigla	Firma	Sigla	Firma	Sigla	Firma
	2020-07-03	Relazione tecnica		FR		JA		FM	
				Redazione		Controllo-emissione		autorizzazione	

Nome file: Vari	Codice commessa: 19101SASA	Data: Luglio 2020
-----------------	----------------------------	-------------------

*Progetto per la realizzazione di nuovo deposito
della ditta trasporti internazionali Transmec S.p.A.,
Campogalliano (MO)*

STUDIO ACUSTICO-INTEGRAZIONI

INDICE

1.	NOTA INTEGRATIVA	1
----	------------------------	---

ALLEGATI

- *Planimetri di progetto riportante posizionamento impianti in copertura e percorsi interni dei mezzi*
- *schede tecniche degli impianti in copertura*

1. NOTA INTEGRATIVA

Facendo seguito alle richieste di integrazione di ARPAE contenute nel Verbale della Struttura Tecnica Operativa del CUAV della Provincia di Modena del 19/06/2020, con il presente documento si integra lo Studio Acustico relativo all'Accordo Operativo art. 38 LR 24/2017 – Transmec nel Comune di Campogalliano.

In tema di acustica, la nota di ARPAE richiede quanto segue:

1. si riporta una carta di zonizzazione acustica non aggiornata che attribuisce all'area d'intervento una classe acustica di tipo III (area mista), quando invece, dalla Tav. 3 – Classificazione acustica – allegata al vigente strumento urbanistico PSC, si rileva che gli ambiti interessati dal progetto (ASP_S_E 47.32 e ASP_S_C 45.35) sono stati attribuiti ad una Classe V (di fatto e di progetto) – area prevalentemente industriale - con limiti assoluti pari a 70 dBA di giorno e 60 dBA di notte;
2. non sono riportate le caratteristiche costruttive degli impianti tecnologici e il relativo posizionamento sulla copertura del fabbricato, necessario per valutare le distanze che intercorrono tra sorgenti e ricettore;
3. non è stato stimato il contributo di rumore indotto dal traffico veicolare (leggeri e pesanti) da e per l'insediamento che ricade sulla viabilità esistente in quanto considerato ininfluenza;
4. non è stato riportato il percorso della viabilità interna, al fine di consentire, in particolare ai mezzi pesanti di compiere percorso ben definito volto a rendere il transito più fruibile e mitigare il rumore;
5. Non sono previste valutazioni/stime della rumorosità ambientale per le aree di manovra e parcheggi, per le quali il progetto ne prevede l'ampliamento: ulteriori n. 692 posti auto di cui n. 446 privati (di cui n. 398 per l'ambito 47.32 e n. 48 per l'ambito 45.35) e n. 246 pubblici privati (di cui n. 183 per l'ambito 47.32 e n. 63 per l'ambito 45.35).

In merito al **punto 1.** si riporta di seguito un estratto della Classificazione acustica aggiornata, ove emerge che gli ambiti interessati dal progetto (ASP_S_E 47.32 e ASP_S_C 45.35 - cerchiata in verde) sono attribuiti ad una Classe V (di fatto e di progetto) – area prevalentemente industriale - con limiti assoluti pari a 70 dBA di giorno e 60 dBA di notte.

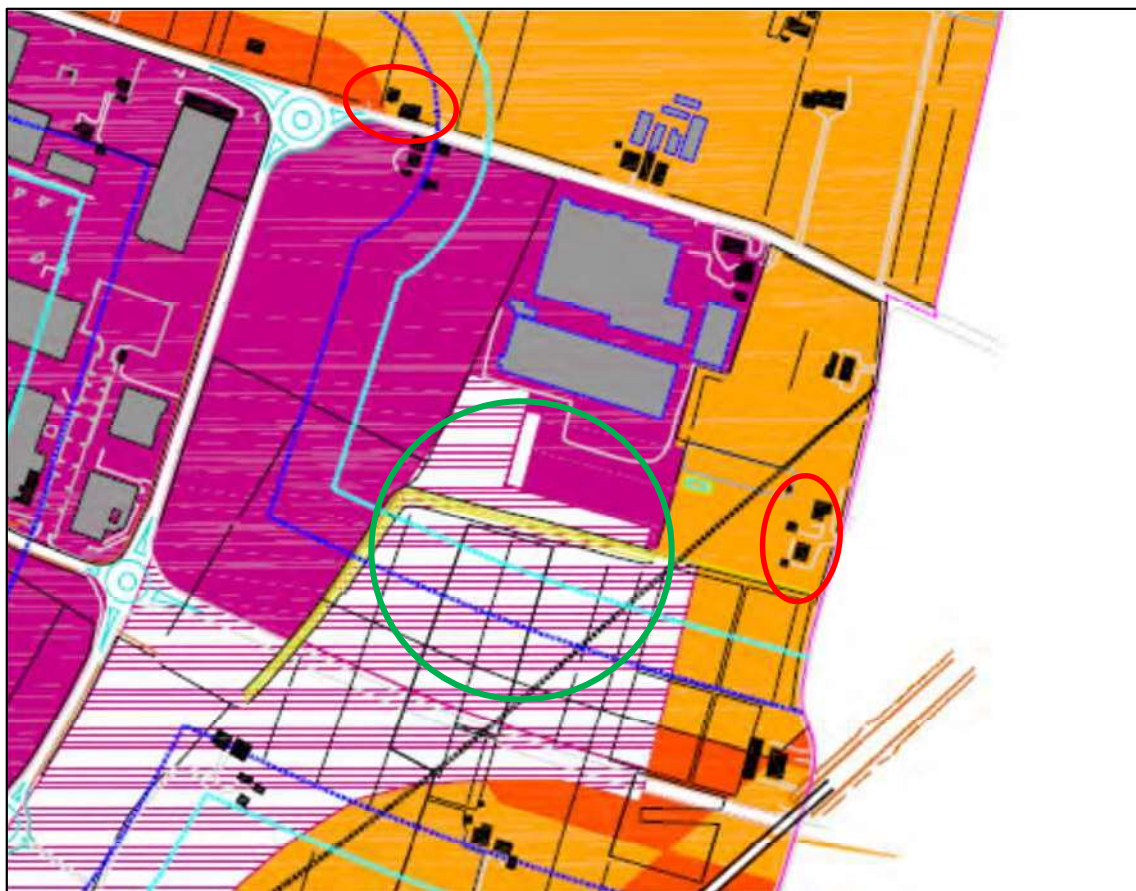

Rimangono valide le considerazioni effettuate nello Studio Acustico relativamente ai ricettori sui quali sono state svolte le verifiche di impatto acustico correlato alla sorgente oggetto di valutazione (cerchiati in rosso), che ricadono:

- in III classe acustica con limiti massimi di immissione pari a 60 dBA nel periodo diurno e 50 dBA nel periodo notturno i recettori residenziali posti a est dei futuri edifici

In merito ai **punti 2.** e **4.** si riportano in allegato una tavola con l'individuazione della localizzazione degli impianti in copertura ai due fabbricati dei percorsi dei mezzi all'interno dell'area di progetto, nonché le schede tecniche degli impianti stessi. Si noti che tali schede sono rappresentative della tipologia di impianti che sarà installata, la marca e il modello non sono ancora certi.

In merito ai **punti 3.** e **5.** Si riportano di seguito i livelli calcolati sui ricettori, individuati nella figura seguente, in uno scenario futuro in cui sono considerati anche i flussi di traffico indotti nonché il contributo dei parcheggi di progetto.

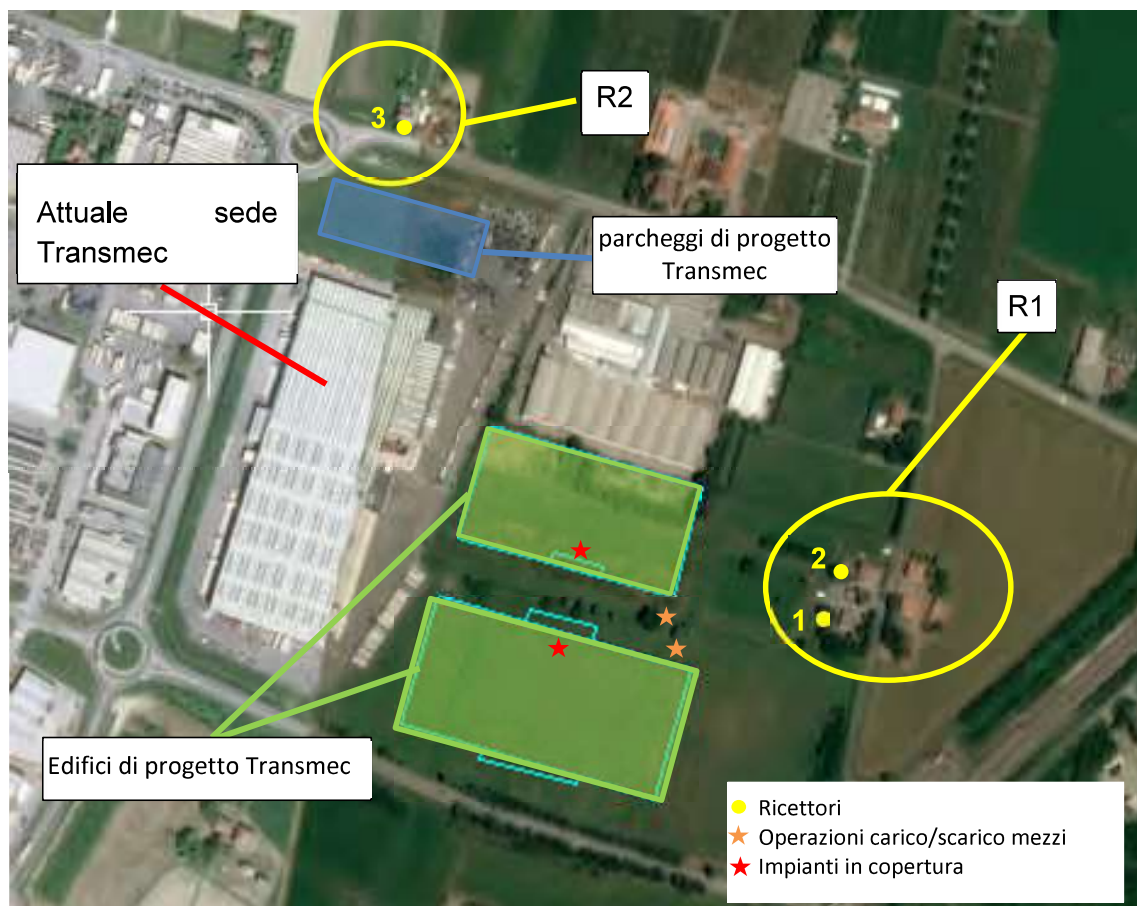

La tabella seguente riporta i livelli acustici sui ricettori nella situazione ante operam.

Ricettore	Piano	Limiti di immissione	Contributo traffico
		Leq D - dBA	Leq D - dBA
1	1	60	50,87
1	2	60	51,13
2	1	60	44,02
2	2	60	48,03
3	1	60	45,83
3	2	60	47,18

La tabella seguente riporta la verifica dei limiti assoluti di immissione e di emissione sui ricettori 1, 2, 3 in uno scenario che vede i flussi di traffico sulla viabilità ordinaria, i flussi di traffico indotti dall'intervento, il contributo dei parcheggi, delle operazioni di carico/scarico e degli impianti in copertura.

Ricettore	Piano	Limiti di immissione	Limiti di emissione	Contributo traffico	Sorgenti di progetto	Rumore complessivo
		Leq D - dBA	Leq D - dBA	Leq D - dBA	Impianti	Leq D - dBA
					Leq D - dBA	
1	1	60	55	48,44	43,14	49,6
1	2	60	55	48,87	43,14	49,9
2	1	60	55	39,53	39,45	42,5
2	2	60	55	44,21	42,2	46,3
3	1	60	55	52,25	18,82	52,3
3	2	60	55	53,79	19,06	53,8

I valori riportati in tabella mostrano che i ricettori considerati rispettano ampiamente i limiti.

Oltre alla verifica dei limiti assoluti di immissione, per lo scenario di progetto è stata effettuata anche la verifica del criterio differenziale, relativamente alle operazioni di carico e scarico e agli impianti tecnologici installati sulle coperture dei fabbricati.

Nella verifica del criterio differenziale non sono stati considerati i flussi di traffico indotti in quanto normativamente il traffico veicolare è escluso da tale verifica.

Cautelativamente, il rumore residuo è stato ipotizzato pari al minimo livello di rumore misurato durante la campagna di rilievo in corrispondenza della postazione P1. Tale livello, registrato tra le 14 e le 15 del giorno 04/09/2016, è pari a 44.7 dB ed è stato assunto come rumore residuo per i tutti ricettori residenziali analizzati.

Ricettore	Piano	Limite normativo	Rumore residuo	Sorgenti di progetto	Rumore ambientale	Differenziale
		Leq D - dBA	Leq D - dBA	Impianti	Leq D - dBA	Leq D - dBA
				Leq D - dBA		
1	1	5	44,7	43,2	47,0	-
1	2	5	44,7	43,2	47,0	-
2	1	5	44,7	39,4	45,8	-
2	2	5	44,7	42,2	46,6	-
3	1	5	44,7	18,82	44,7	-
3	2	5	44,7	19,06	44,7	-

Dalla tabella è evidente come il rumore ambientale sia sempre inferiore a 50 dB, rendendo non applicabile la verifica del criterio differenziale. Appare comunque evidente che l'apporto risulta sempre al di sotto dei 5 dBA previsti come limite normativo.

ALLEGATI

- Planimetri di progetto riportante posizionamento impianti in copertura e percorsi interni dei mezzi
- schede tecniche degli impianti in copertura

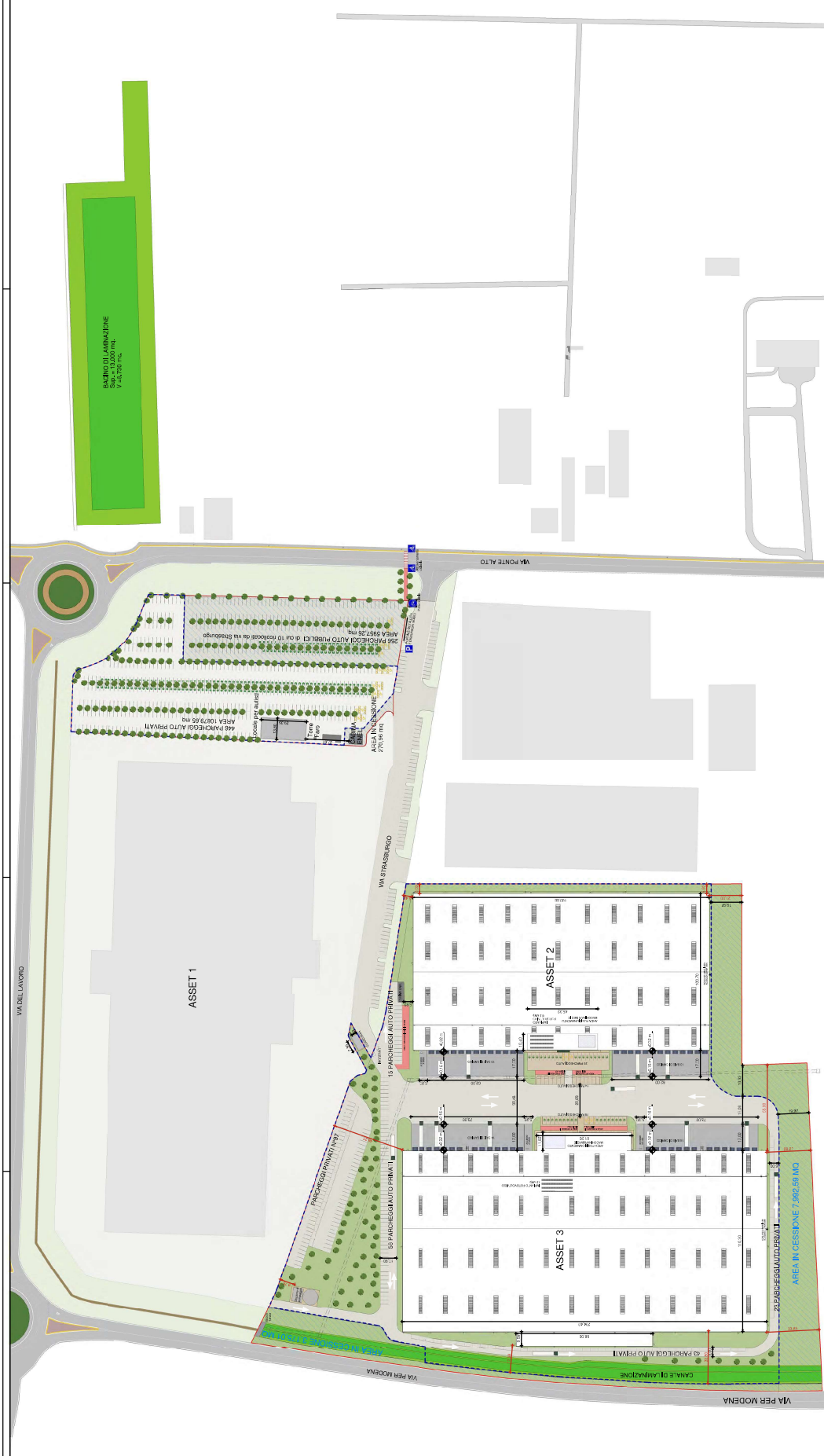

DATI PROGETTO	TOTALE	ASSET 1	ASSET 2	ASSET 3	GIARDI	LOC AUT	UM
SUPERFICIE TERRESTRIALE	102.040,00						m ²
SUPERFICIE ECONOMICA	14.263,18						m ²
SUPERFICIE COPERTA	45.092,42	15.756,46	25.702,42	22.252			65.033
SUPERFICIE UTILE	48.002,22	15.480,42	25.434,28	17,28			58.843
SUPERFICIE VERDE	5.002,50						m ²
SUPERFICIE VERDE IN CESSIONE	11.362,62						m ²
AREA PARCHING IN CESSIONE	6.282,22						m ²
AREA IN CESSIONE TOTALE	17.644,84						m ²
IMP. PARCHING (M ²)	481,11	10,607	251,27				m ²
IMP. PARCHING (M ²)	390,54	10,607	251,27				m ²
SUPERFICIE PARCHING IN CESS.	4.647,20	12,18,97	2.000,22				m ²
SUPERFICIE PARCHING IN CESS.	4.647,20	12,18,97	2.000,22				m ²
SUPERFICIE PARCHING IN CESS.	1.482,22	204,23	204,24				m ²
SUPERFICIE PARCHING IN CESS.	11.626,09						m ²

--- C --- CANALI IN SEGNO COPIANTE
 P --- AREA CENSIBILE
 P --- CARTELLI DI ACCESSO AL PARCHINGE CON LOMI APERTURA



COMUNE DI CAMPOGALLIANO (MO)

PROGETTO PER LA
REALIZZAZIONE DI NUOVI DEPOSITI E
RELATIVI UFFICI

DATA: 03/07/2020
 SCALE: 1 : 900
 PLANIVOLUMETRICO

LABORATORIO
Architettura e Sviluppo SpA
 LOMBARDA E DI BIELLA
 VIA S. PIETRO 10 - 10121 TORINO (TO)

SOCIETA' CONSORTILE
GSG
 SERRAVALLE
 VIA S. PIETRO 10 - 10121 TORINO (TO)

STUDIO DI ARCHITETTURA
Studio Dall'Aglio Scattolon
 VIA S. PIETRO 10 - 10121 TORINO (TO)

STUDIO DI ARCHITETTURA
SPARE
 VIA S. PIETRO 10 - 10121 TORINO (TO)

Commessa **114933** Fase **IPR** Lotta **200** Disegno **102** Foglio **A**

5-1. Sound levels in cooling mode

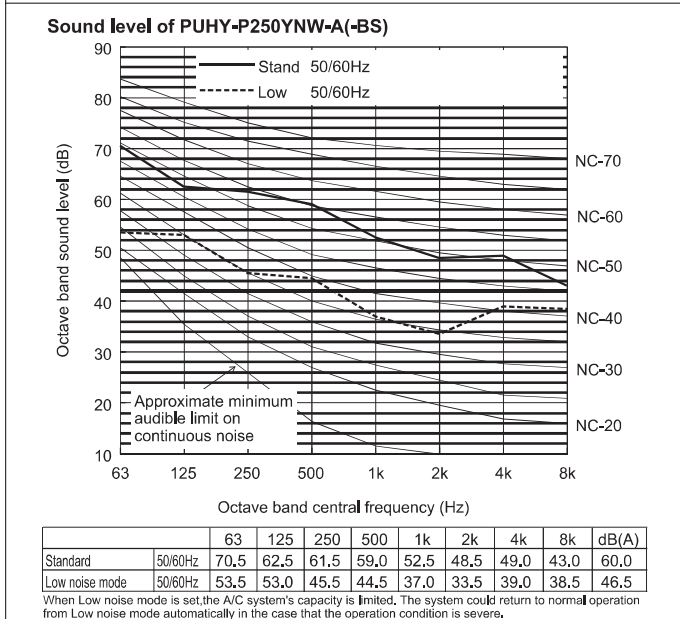
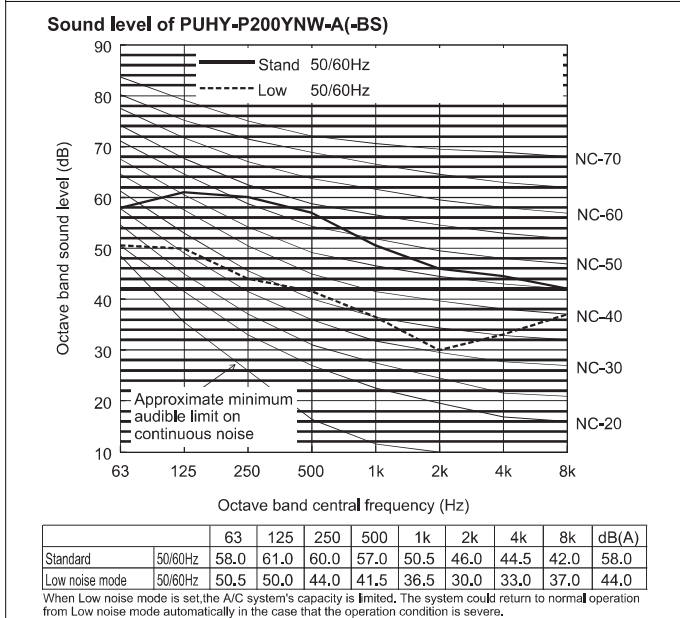
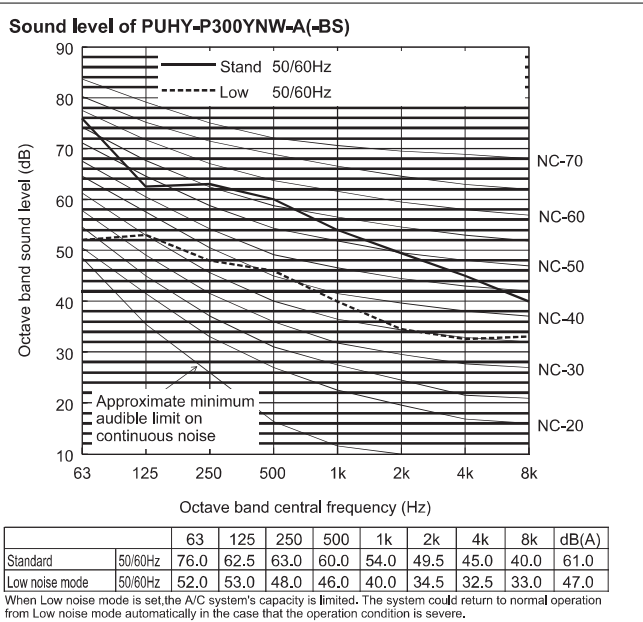
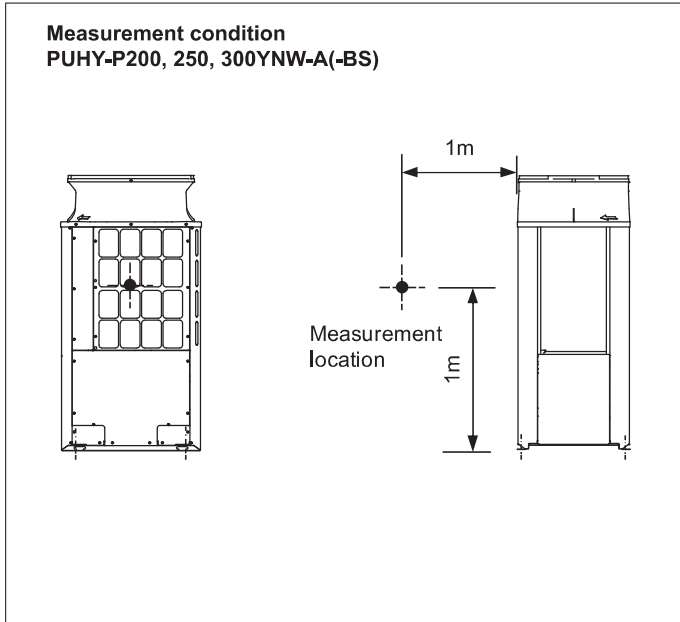

♦ Depending on the operation conditions, the unit generates noise caused by valve actuation, refrigerant flow, and pressure changes when operating normally. Please consider to avoid location where quietness is required.

Measurement condition
PUHY-P350, 400, 450YNW-A(-BS)

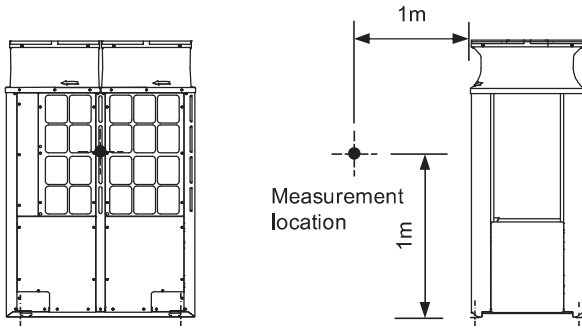

Sound level of PUHY-P450YNW-A(-BS)

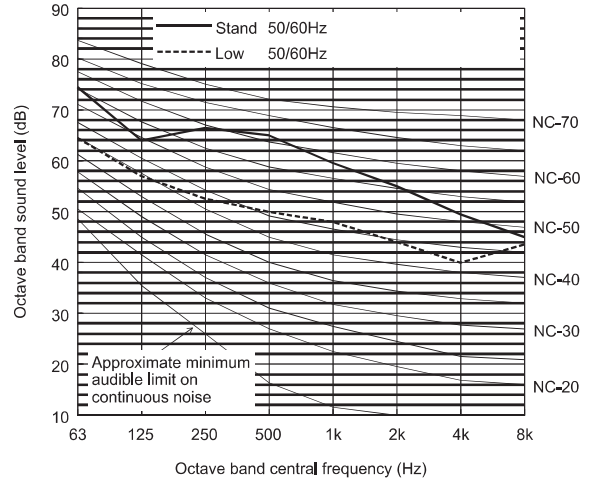

		63	125	250	500	1k	2k	4k	8k	dB(A)
Standard	50/60Hz	74.5	64.0	66.5	65.0	59.5	55.0	49.5	45.0	65.5
Low noise mode	50/60Hz	64.5	57.0	52.5	50.0	48.0	44.0	40.0	43.5	53.5

When Low noise mode is set, the A/C system's capacity is limited. The system could return to normal operation from Low noise mode automatically in the case that the operation condition is severe.

Sound level of PUHY-P350YNW-A(-BS)

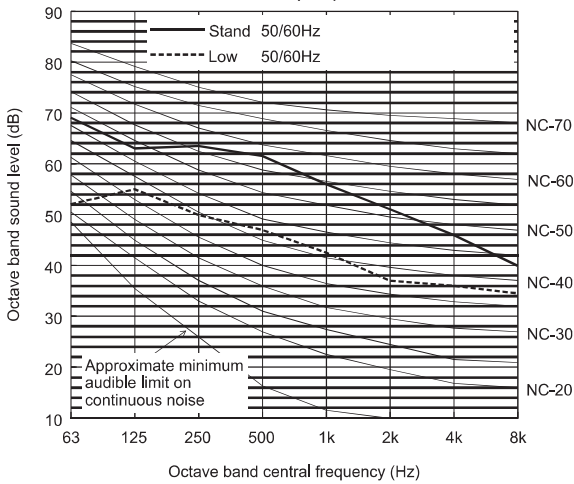

		63	125	250	500	1k	2k	4k	8k	dB(A)
Standard	50/60Hz	69.0	63.0	63.5	61.5	56.0	51.0	46.0	40.0	62.0
Low noise mode	50/60Hz	52.0	55.0	50.0	47.0	42.5	37.0	36.0	34.5	49.0

When Low noise mode is set, the A/C system's capacity is limited. The system could return to normal operation from Low noise mode automatically in the case that the operation condition is severe.

Sound level of PUHY-P400YNW-A(-BS)

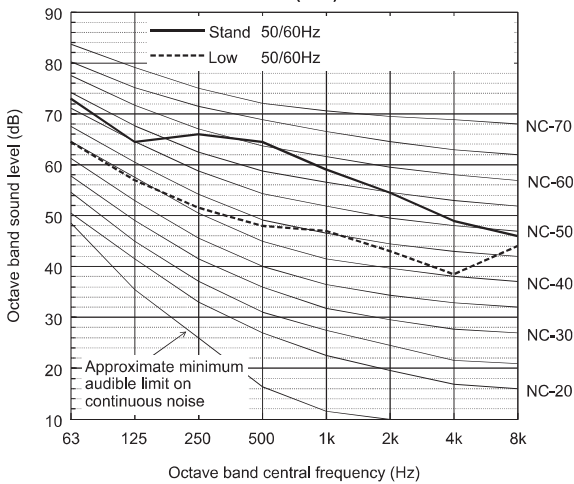

		63	125	250	500	1k	2k	4k	8k	dB(A)
Standard	50/60Hz	73.0	64.5	66.0	64.5	59.0	54.5	49.0	46.0	65.0
Low noise mode	50/60Hz	64.5	57.0	51.5	48.0	47.0	43.0	38.5	44.0	52.5

When Low noise mode is set, the A/C system's capacity is limited. The system could return to normal operation from Low noise mode automatically in the case that the operation condition is severe.

◆ Depending on the operation conditions, the unit generates noise caused by valve actuation, refrigerant flow, and pressure changes when operating normally. Please consider to avoid location where quietness is required.

PUHY-P-Y(S)NW-A

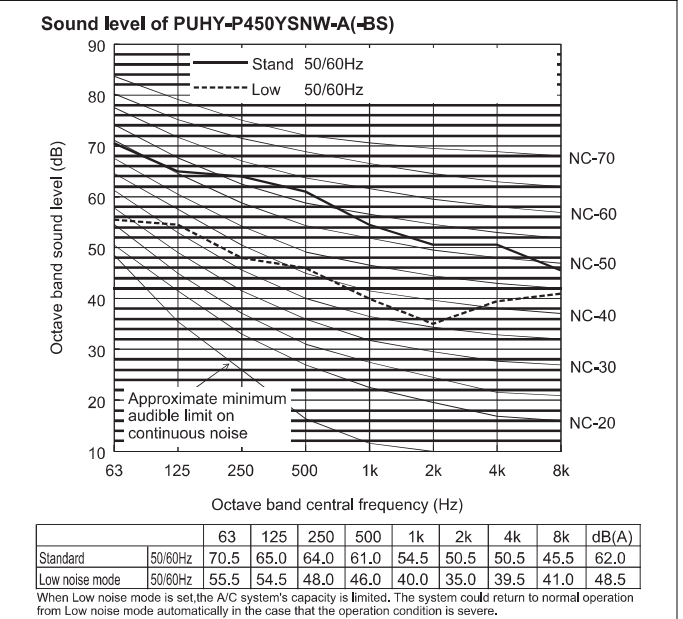
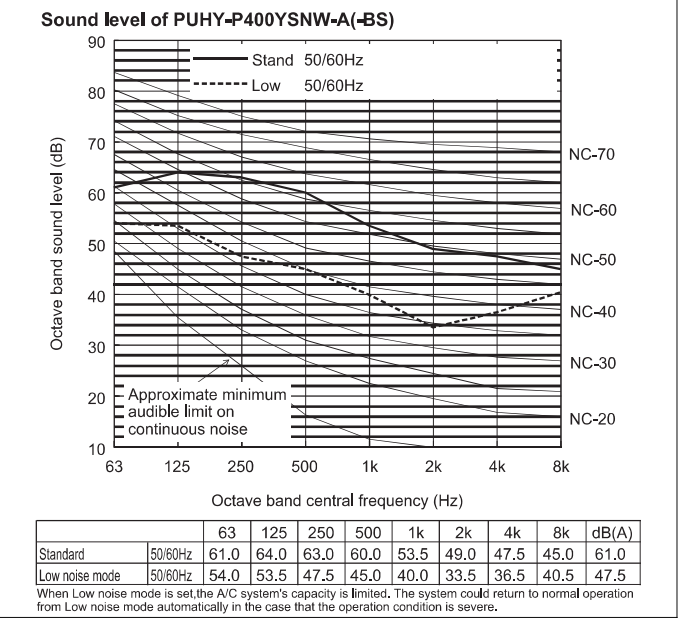
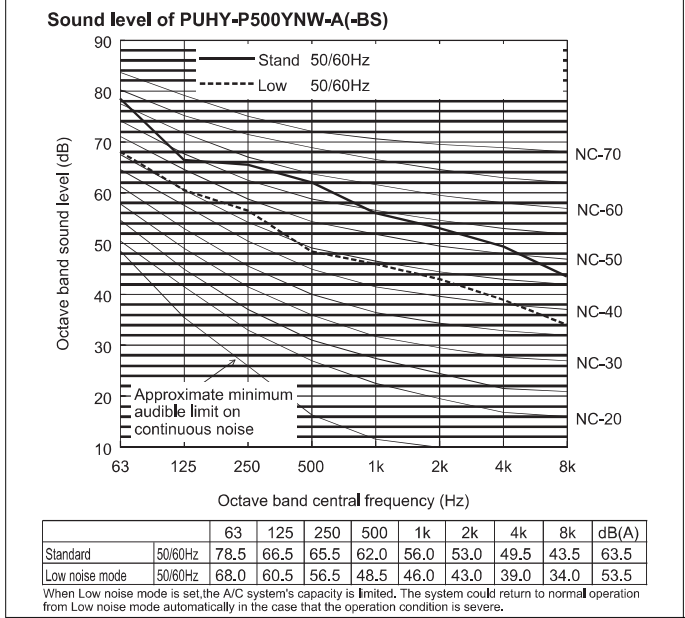
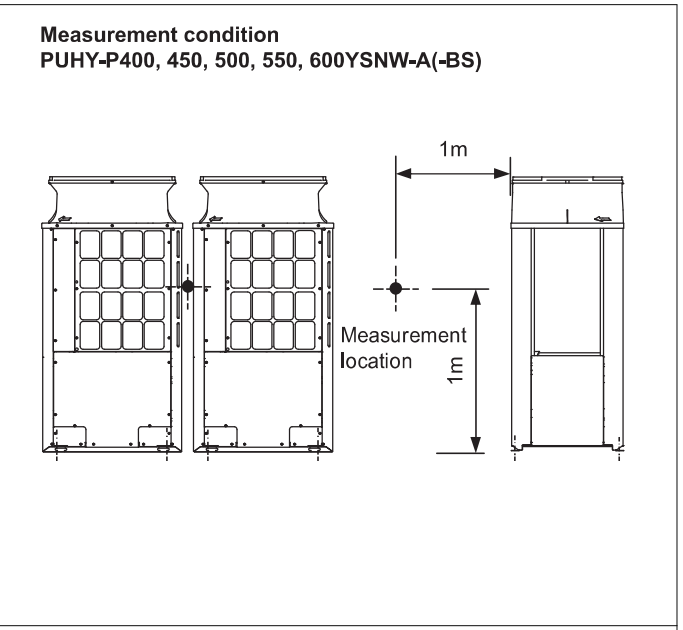
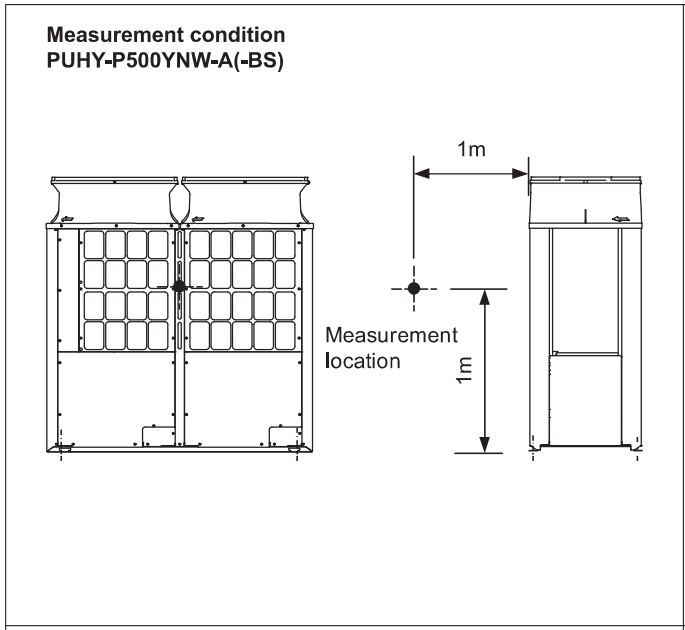

◆ Depending on the operation conditions, the unit generates noise caused by valve actuation, refrigerant flow, and pressure changes when operating normally. Please consider to avoid location where quietness is required.

Sound level of PUHY-P500YSNW-A(-BS)

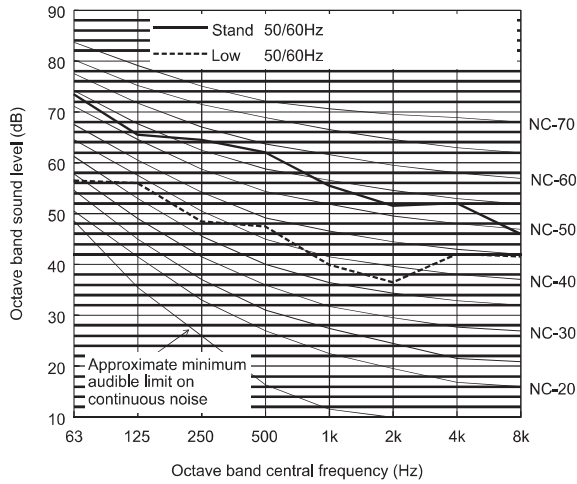

		63	125	250	500	1k	2k	4k	8k	dB(A)
Standard	50/60Hz	73.5	65.5	64.5	62.0	55.5	51.5	52.0	46.0	63.0
Low noise mode	50/60Hz	56.5	56.0	48.5	47.5	40.0	36.5	42.0	41.5	49.5

When Low noise mode is set, the A/C system's capacity is limited. The system could return to normal operation from Low noise mode automatically in the case that the operation condition is severe.

Measurement condition
PUHY-P650YSNW-A(-BS)

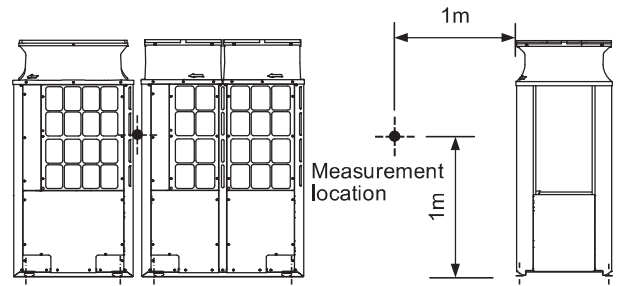

Sound level of PUHY-P550YSNW-A(-BS)

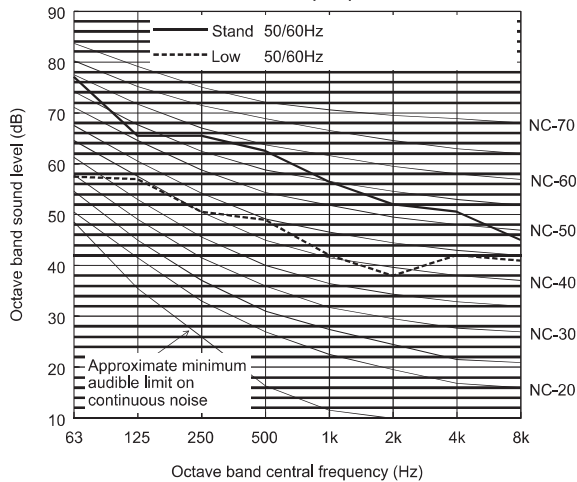

		63	125	250	500	1k	2k	4k	8k	dB(A)
Standard	50/60Hz	77.0	65.5	65.5	62.5	56.5	52.0	50.5	45.0	63.5
Low noise mode	50/60Hz	57.5	57.0	50.5	49.0	42.0	38.0	42.0	41.0	51.0

When Low noise mode is set, the A/C system's capacity is limited. The system could return to normal operation from Low noise mode automatically in the case that the operation condition is severe.

Sound level of PUHY-P650YSNW-A(-BS)

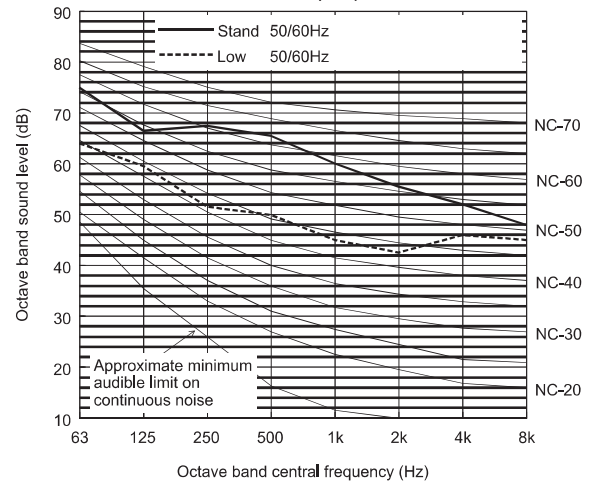

		63	125	250	500	1k	2k	4k	8k	dB(A)
Standard	50/60Hz	75.0	66.5	67.5	65.5	60.0	55.5	52.0	48.0	66.5
Low noise mode	50/60Hz	64.0	59.5	51.5	50.0	45.0	42.5	46.0	45.0	53.5

When Low noise mode is set, the A/C system's capacity is limited. The system could return to normal operation from Low noise mode automatically in the case that the operation condition is severe.

Sound level of PUHY-P600YSNW-A(-BS)

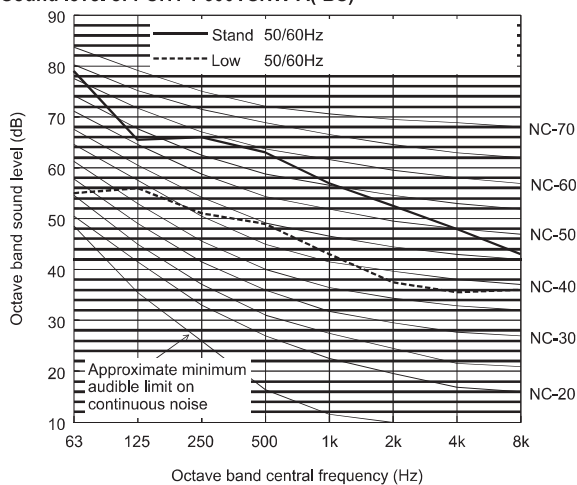

		63	125	250	500	1k	2k	4k	8k	dB(A)
Standard	50/60Hz	79.0	65.5	66.0	63.0	57.0	52.5	48.0	43.0	64.0
Low noise mode	50/60Hz	55.0	56.0	51.0	49.0	43.0	37.5	35.5	36.0	50.0

When Low noise mode is set, the A/C system's capacity is limited. The system could return to normal operation from Low noise mode automatically in the case that the operation condition is severe.

◆ Depending on the operation conditions, the unit generates noise caused by valve actuation, refrigerant flow, and pressure changes when operating normally. Please consider to avoid location where quietness is required.

PUHY-P-Y(S)NW-A

Measurement condition
PUHY-P700, 750, 800, 850, 900YSNW-A(-BS)

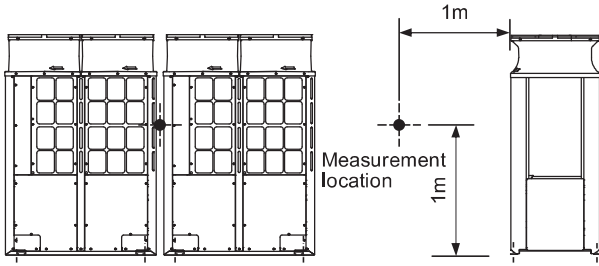

Sound level of PUHY-P800YSNW-A(-BS)

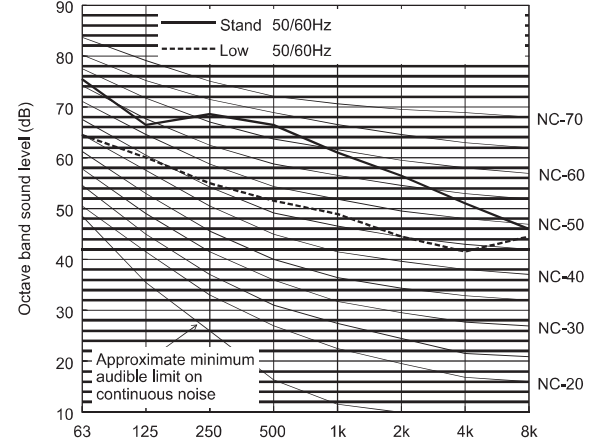

		63	125	250	500	1k	2k	4k	8k	dB(A)
Standard	50/60Hz	75.5	66.5	68.5	66.5	61.0	56.5	51.0	46.0	67.5
Low noise mode	50/60Hz	64.5	60.0	55.0	51.5	49.0	44.5	41.5	44.5	55.0

When Low noise mode is set, the A/C system's capacity is limited. The system could return to normal operation from Low noise mode automatically in the case that the operation condition is severe.

Sound level of PUHY-P700YSNW-A(-BS)

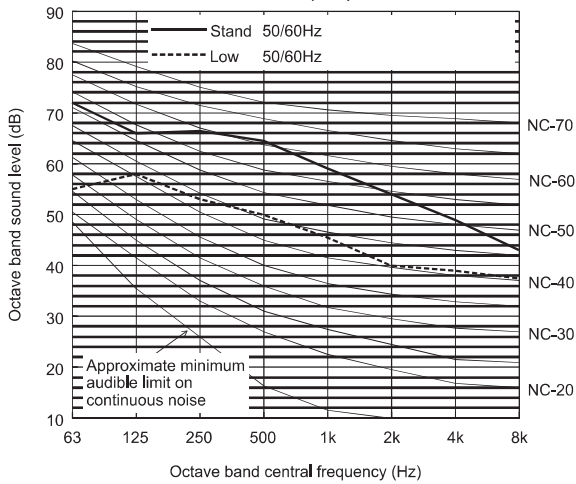

		63	125	250	500	1k	2k	4k	8k	dB(A)
Standard	50/60Hz	72.0	66.0	66.5	64.5	59.0	54.0	49.0	43.0	65.0
Low noise mode	50/60Hz	55.0	58.0	53.0	50.0	45.5	40.0	39.0	37.5	52.0

When Low noise mode is set, the A/C system's capacity is limited. The system could return to normal operation from Low noise mode automatically in the case that the operation condition is severe.

Sound level of PUHY-P850YSNW-A(-BS)

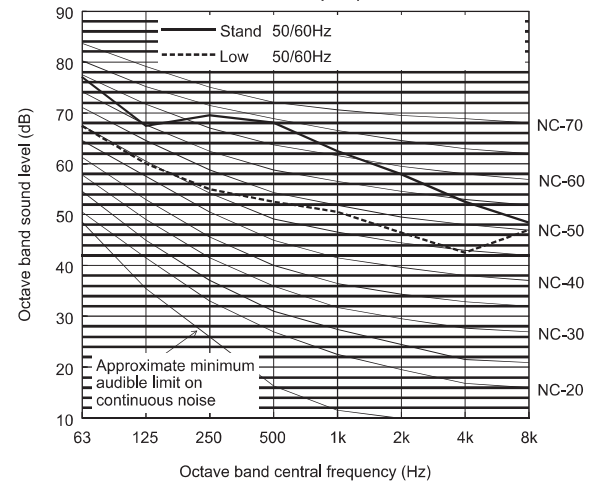

		63	125	250	500	1k	2k	4k	8k	dB(A)
Standard	50/60Hz	77.5	67.5	69.5	68.0	62.5	58.0	52.5	48.5	68.5
Low noise mode	50/60Hz	67.5	60.0	55.0	52.5	50.5	46.5	42.5	47.0	56.0

When Low noise mode is set, the A/C system's capacity is limited. The system could return to normal operation from Low noise mode automatically in the case that the operation condition is severe.

Sound level of PUHY-P750YSNW-A(-BS)

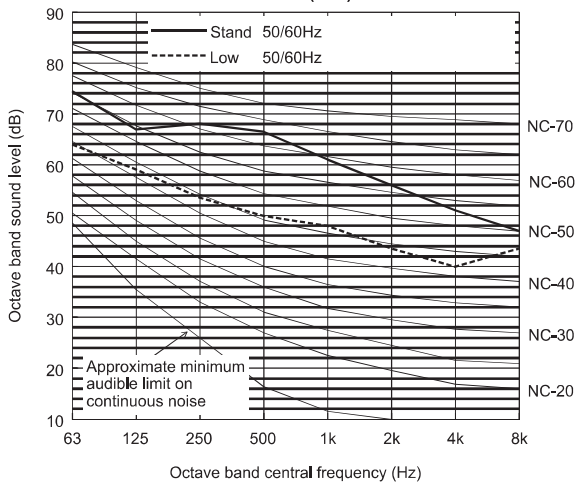

		63	125	250	500	1k	2k	4k	8k	dB(A)
Standard	50/60Hz	74.5	67.0	68.0	66.5	61.0	56.0	51.0	47.0	67.0
Low noise mode	50/60Hz	64.0	59.0	53.5	50.0	48.0	43.5	40.0	43.5	53.5

When Low noise mode is set, the A/C system's capacity is limited. The system could return to normal operation from Low noise mode automatically in the case that the operation condition is severe.

Sound level of PUHY-P900YSNW-A(-BS)

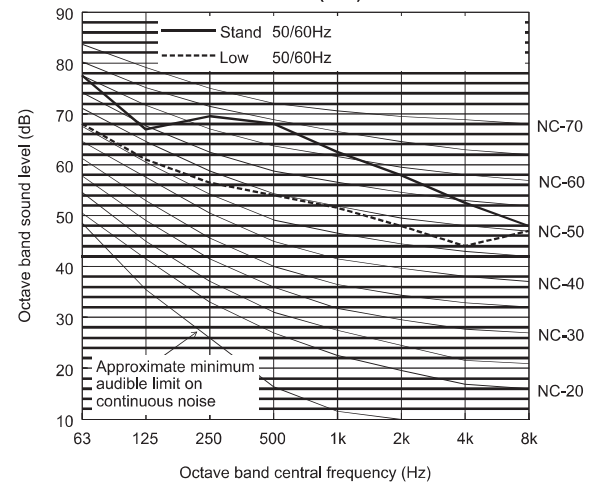

		63	125	250	500	1k	2k	4k	8k	dB(A)
Standard	50/60Hz	77.5	67.0	69.5	68.0	62.5	58.0	52.5	48.0	68.5
Low noise mode	50/60Hz	68.0	61.0	56.5	54.0	51.5	48.0	44.0	47.0	57.0

When Low noise mode is set, the A/C system's capacity is limited. The system could return to normal operation from Low noise mode automatically in the case that the operation condition is severe.

♦ Depending on the operation conditions, the unit generates noise caused by valve actuation, refrigerant flow, and pressure changes when operating normally. Please consider to avoid location where quietness is required.

Measurement condition
PUHY-P950, 1000, 1050YSNW-A(-BS)

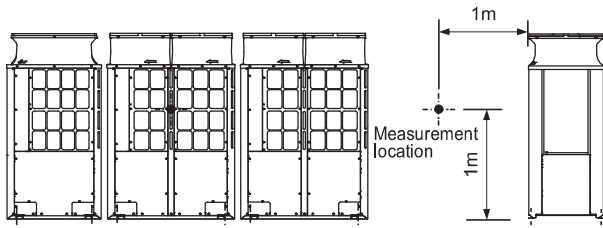

Sound level of PUHY-P1050YSNW-A(-BS)

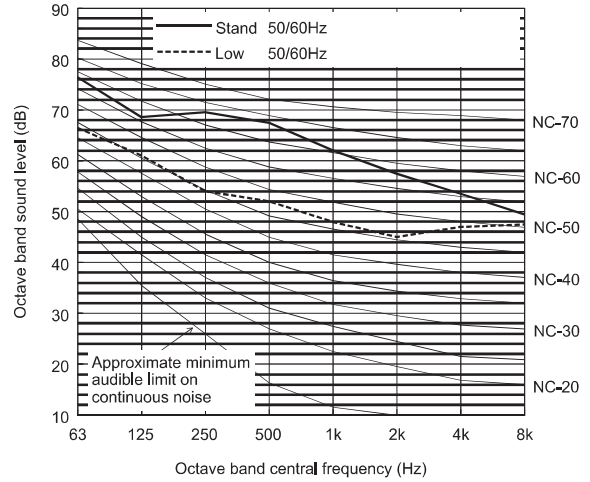

		63	125	250	500	1k	2k	4k	8k	dB(A)
Standard	50/60Hz	76.5	68.5	69.5	67.5	62.0	57.5	53.5	49.5	68.5
Low noise mode	50/60Hz	66.5	61.0	54.0	52.0	48.0	45.0	47.0	47.5	55.5

When Low noise mode is set, the A/C system's capacity is limited. The system could return to normal operation from Low noise mode automatically in the case that the operation condition is severe.

Sound level of PUHY-P950YSNW-A(-BS)

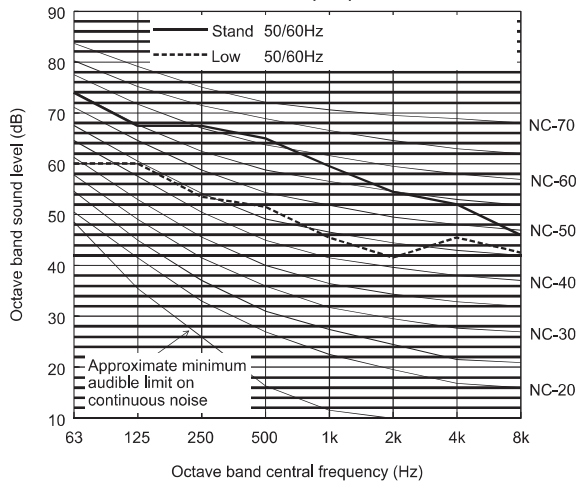

		63	125	250	500	1k	2k	4k	8k	dB(A)
Standard	50/60Hz	74.0	67.5	67.5	65.0	59.5	54.5	52.0	46.0	66.0
Low noise mode	50/60Hz	60.0	60.0	53.5	51.5	45.5	41.5	45.5	42.5	54.0

When Low noise mode is set, the A/C system's capacity is limited. The system could return to normal operation from Low noise mode automatically in the case that the operation condition is severe.

Sound level of PUHY-P1000YSNW-A(-BS)

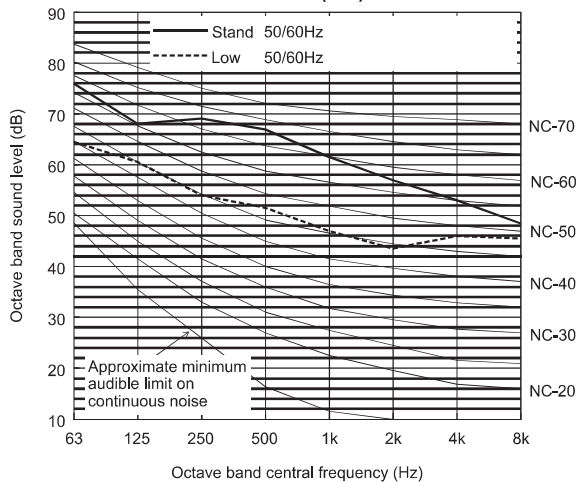

		63	125	250	500	1k	2k	4k	8k	dB(A)
Standard	50/60Hz	76.0	68.0	69.0	67.0	61.5	57.0	53.0	48.5	68.0
Low noise mode	50/60Hz	64.5	60.5	54.0	51.5	47.0	43.5	46.0	45.5	54.5

When Low noise mode is set, the A/C system's capacity is limited. The system could return to normal operation from Low noise mode automatically in the case that the operation condition is severe.

◆ Depending on the operation conditions, the unit generates noise caused by valve actuation, refrigerant flow, and pressure changes when operating normally. Please consider to avoid location where quietness is required.

Measurement condition
PUHY-P1100, 1150, 1200, 1250, 1300, 1350YSNW-A(-BS)

Sound level of PUHY-P1200YSNW-A(-BS)

		63	125	250	500	1k	2k	4k	8k	dB(A)
Standard	50/60Hz	78.0	69.5	71.0	69.5	64.0	59.5	54.0	51.0	70.0
Low noise mode	50/60Hz	69.0	61.5	55.5	52.5	51.0	47.5	42.5	48.0	56.5

When Low noise mode is set, the A/C system's capacity is limited. The system could return to normal operation from Low noise mode automatically in the case that the operation condition is severe.

Sound level of PUHY-P1100YSNW-A(-BS)

		63	125	250	500	1k	2k	4k	8k	dB(A)
Standard	50/60Hz	75.5	68.5	69.5	67.5	62.0	57.5	52.0	48.0	68.5
Low noise mode	50/60Hz	64.0	60.5	55.0	52.0	49.0	44.5	41.0	44.0	55.0

When Low noise mode is set, the A/C system's capacity is limited. The system could return to normal operation from Low noise mode automatically in the case that the operation condition is severe.

Sound level of PUHY-P1250YSNW-A(-BS)

		63	125	250	500	1k	2k	4k	8k	dB(A)
Standard	50/60Hz	78.5	69.0	71.0	69.5	64.0	59.5	54.0	50.5	70.0
Low noise mode	50/60Hz	69.0	61.5	56.5	53.5	51.5	48.0	43.5	48.5	57.0

When Low noise mode is set, the A/C system's capacity is limited. The system could return to normal operation from Low noise mode automatically in the case that the operation condition is severe.

Sound level of PUHY-P1150YSNW-A(-BS)

		63	125	250	500	1k	2k	4k	8k	dB(A)
Standard	50/60Hz	77.0	69.0	70.0	68.5	63.0	58.5	53.0	49.5	69.0
Low noise mode	50/60Hz	66.5	61.0	55.0	52.0	50.0	45.5	41.5	46.5	55.5

When Low noise mode is set, the A/C system's capacity is limited. The system could return to normal operation from Low noise mode automatically in the case that the operation condition is severe.

Sound level of PUHY-P1300YSNW-A(-BS)

		63	125	250	500	1k	2k	4k	8k	dB(A)
Standard	50/60Hz	79.0	69.0	71.0	69.5	64.0	59.5	54.0	50.0	70.0
Low noise mode	50/60Hz	69.5	62.0	57.0	54.5	52.5	48.5	44.5	48.5	58.0

When Low noise mode is set, the A/C system's capacity is limited. The system could return to normal operation from Low noise mode automatically in the case that the operation condition is severe.

♦ Depending on the operation conditions, the unit generates noise caused by valve actuation, refrigerant flow, and pressure changes when operating normally. Please consider to avoid location where quietness is required.

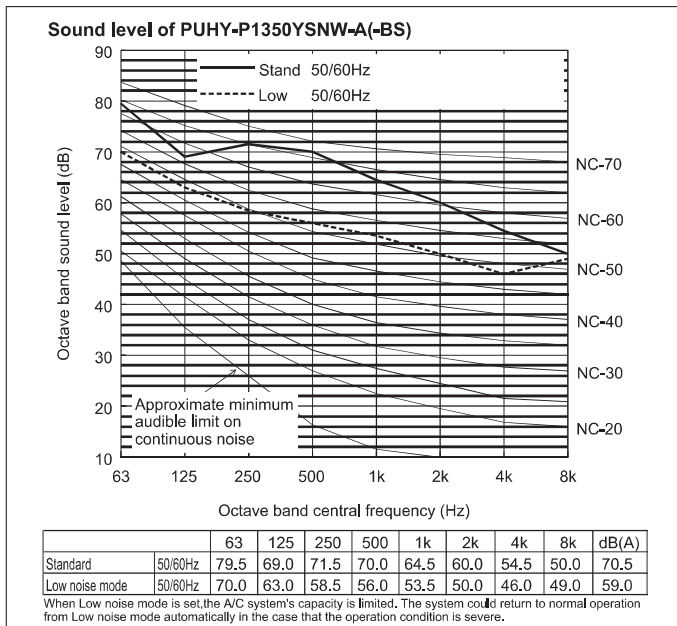

◆ Depending on the operation conditions, the unit generates noise caused by valve actuation, refrigerant flow, and pressure changes when operating normally. Please consider to avoid location where quietness is required.

5-2. Sound levels in heating mode

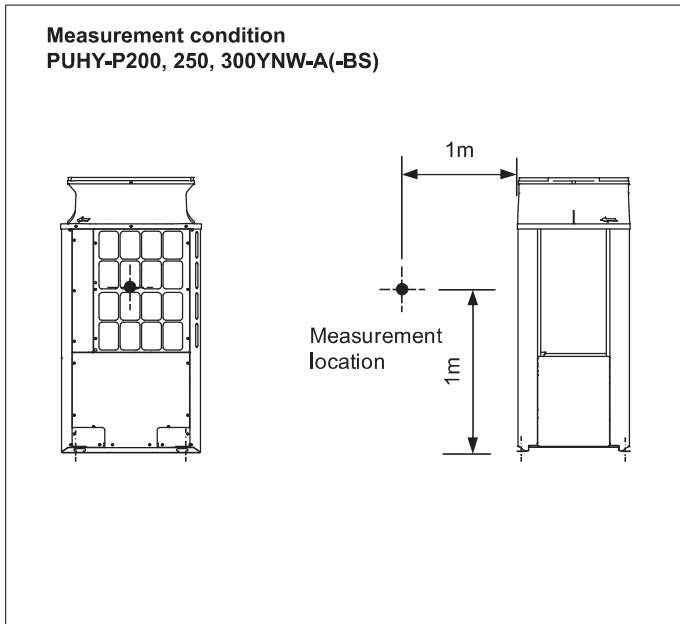

Sound level of PUHY-P300YNW-A(-BS)

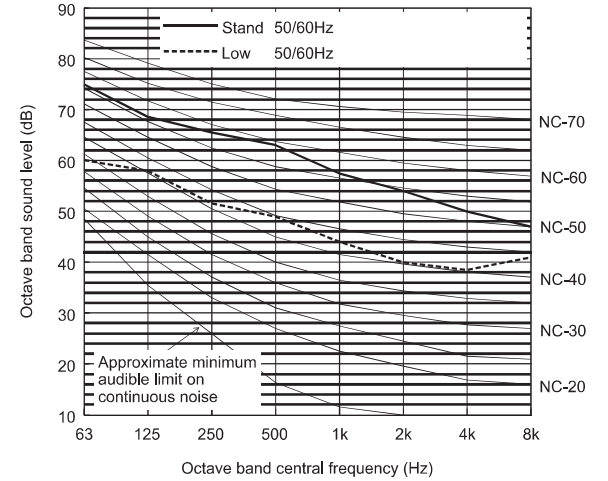

		63	125	250	500	1k	2k	4k	8k	dB(A)
Standard	50/60Hz	75.0	68.5	65.5	63.0	57.5	54.0	50.0	47.0	64.5
Low noise mode	50/60Hz	60.0	58.0	51.5	49.0	44.0	40.0	38.5	41.0	51.0

When Low noise mode is set, the A/C system's capacity is limited. The system could return to normal operation from Low noise mode automatically in the case that the operation condition is severe.

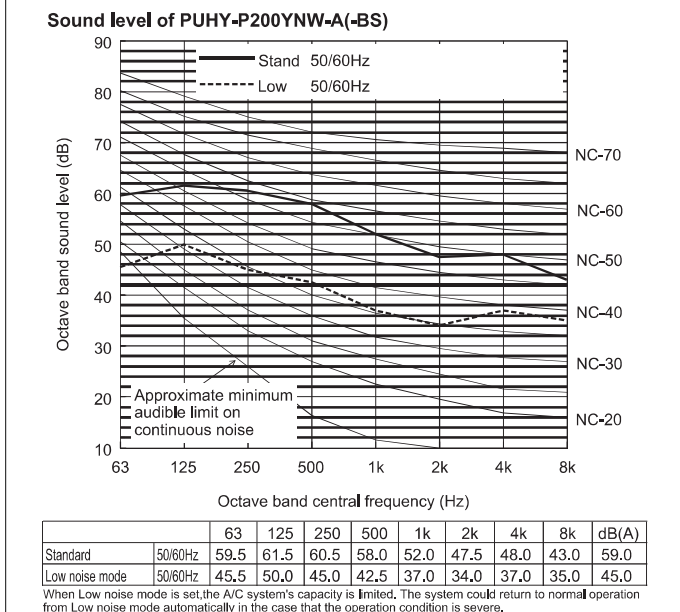

		63	125	250	500	1k	2k	4k	8k	dB(A)
Standard	50/60Hz	59.5	61.5	60.5	58.0	52.0	47.5	48.0	43.0	59.0
Low noise mode	50/60Hz	45.5	50.0	45.0	42.5	37.0	34.0	37.0	35.0	45.0

When Low noise mode is set, the A/C system's capacity is limited. The system could return to normal operation from Low noise mode automatically in the case that the operation condition is severe.

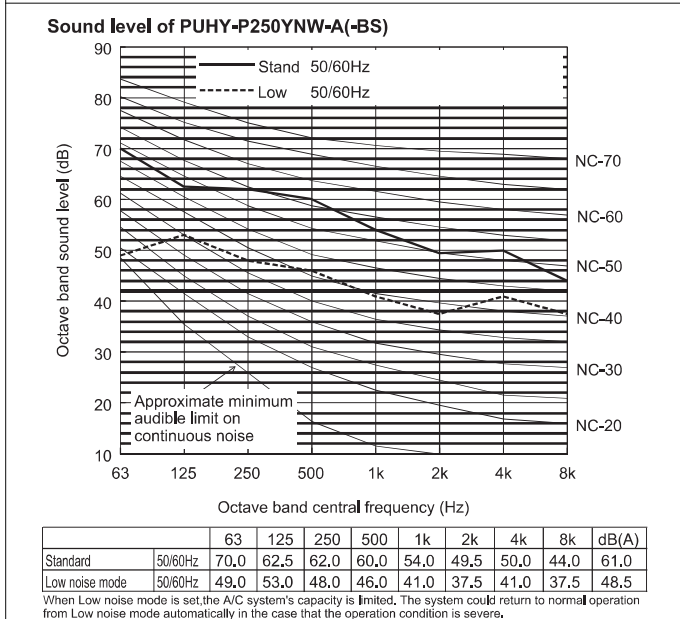

		63	125	250	500	1k	2k	4k	8k	dB(A)
Standard	50/60Hz	70.0	62.5	62.0	60.0	54.0	49.5	50.0	44.0	61.0
Low noise mode	50/60Hz	49.0	53.0	48.0	46.0	41.0	37.5	41.0	37.5	48.5

When Low noise mode is set, the A/C system's capacity is limited. The system could return to normal operation from Low noise mode automatically in the case that the operation condition is severe.

♦ Depending on the operation conditions, the unit generates noise caused by valve actuation, refrigerant flow, and pressure changes when operating normally. Please consider to avoid location where quietness is required.

Measurement condition
PUHY-P350, 400, 450YNW-A(-BS)

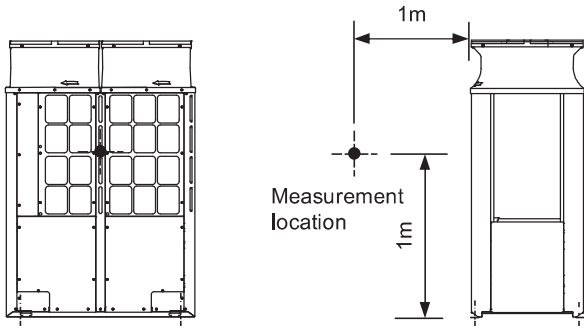

Sound level of PUHY-P450YNW-A(-BS)

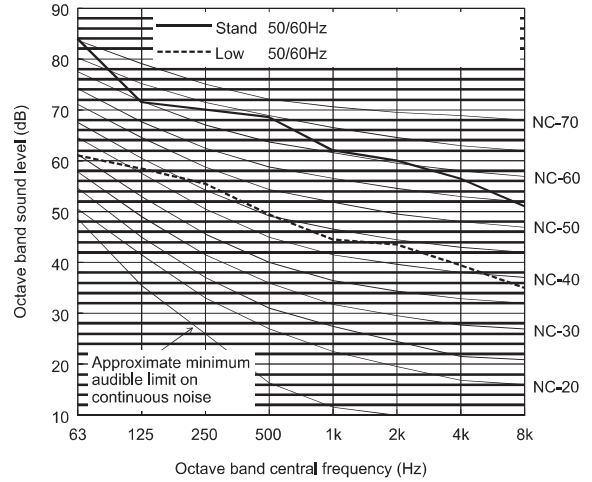

		63	125	250	500	1k	2k	4k	8k	dB(A)
Standard	50/60Hz	84.0	71.5	70.0	68.5	62.0	60.0	56.5	51.0	69.5
Low noise mode	50/60Hz	61.0	58.5	55.5	49.5	44.5	43.5	39.5	35.0	52.5

When Low noise mode is set, the A/C system's capacity is limited. The system could return to normal operation from Low noise mode automatically in the case that the operation condition is severe.

Sound level of PUHY-P350YNW-A(-BS)

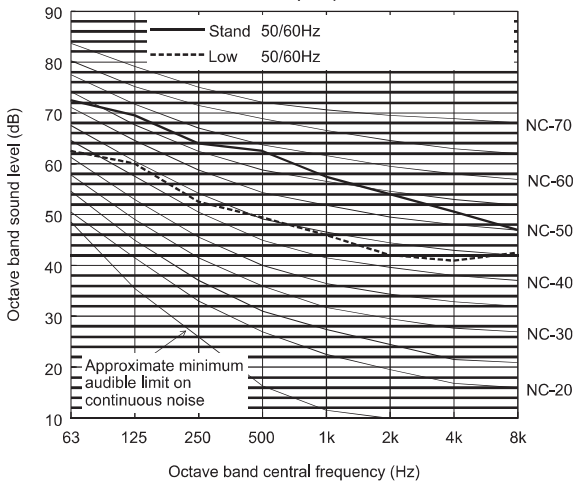

		63	125	250	500	1k	2k	4k	8k	dB(A)
Standard	50/60Hz	72.5	69.5	64.0	62.5	57.5	54.0	50.5	47.0	64.0
Low noise mode	50/60Hz	62.5	60.0	52.5	49.5	46.0	42.0	41.0	42.5	52.5

When Low noise mode is set, the A/C system's capacity is limited. The system could return to normal operation from Low noise mode automatically in the case that the operation condition is severe.

Sound level of PUHY-P400YNW-A(-BS)

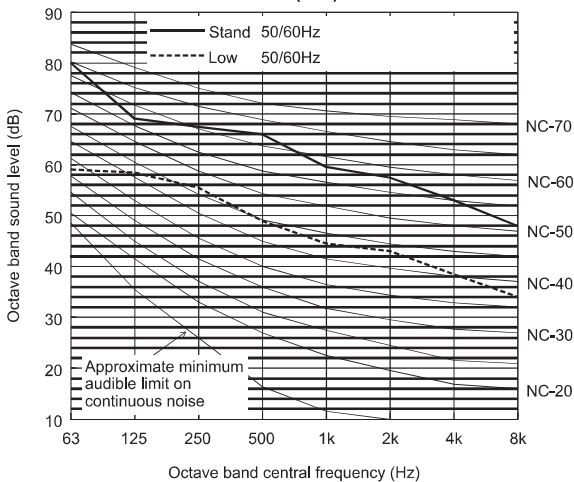

		63	125	250	500	1k	2k	4k	8k	dB(A)
Standard	50/60Hz	80.0	69.0	67.5	66.0	59.5	57.5	53.0	48.0	67.0
Low noise mode	50/60Hz	59.0	58.5	55.5	49.0	44.5	43.0	38.5	34.0	52.5

When Low noise mode is set, the A/C system's capacity is limited. The system could return to normal operation from Low noise mode automatically in the case that the operation condition is severe.

◆ Depending on the operation conditions, the unit generates noise caused by valve actuation, refrigerant flow, and pressure changes when operating normally. Please consider to avoid location where quietness is required.

PUHY-P-Y(S)NW-A

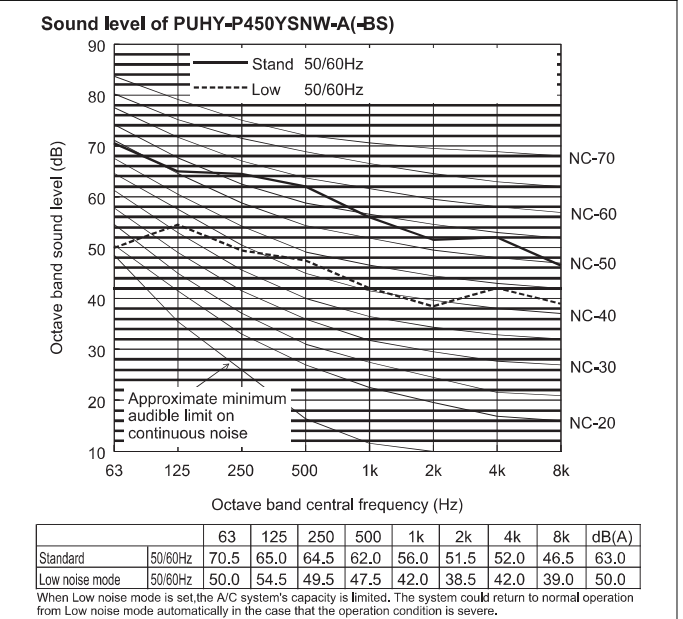
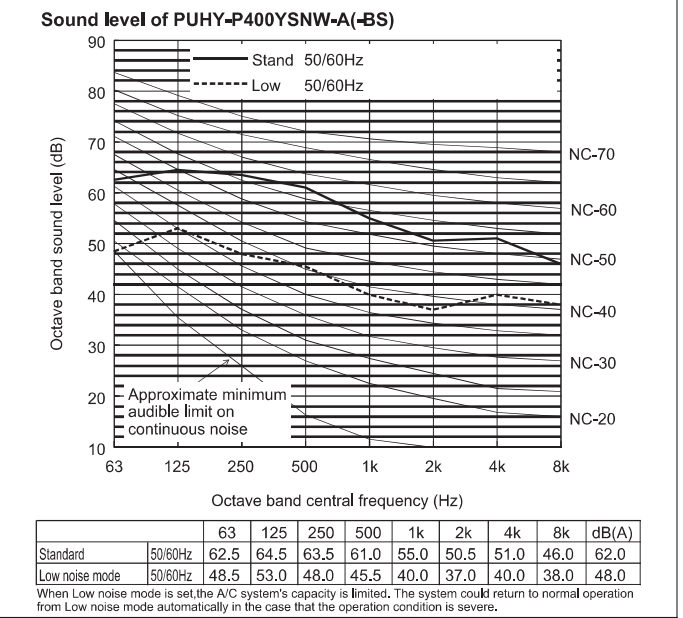
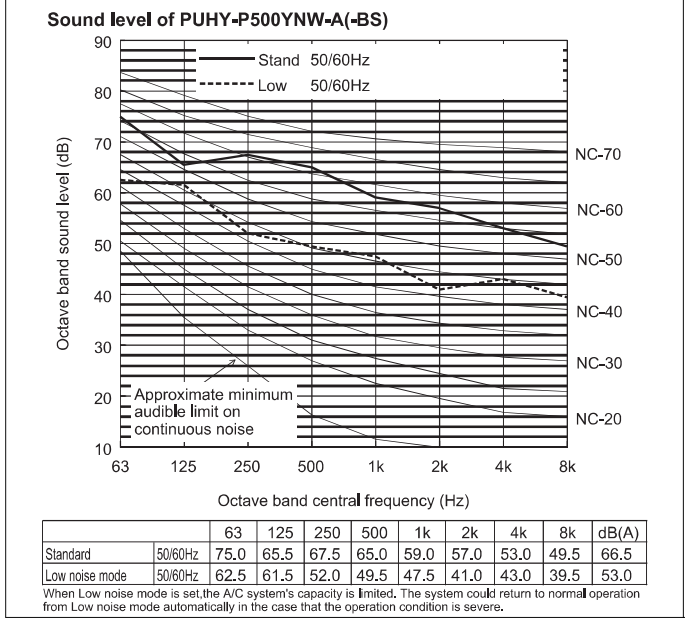
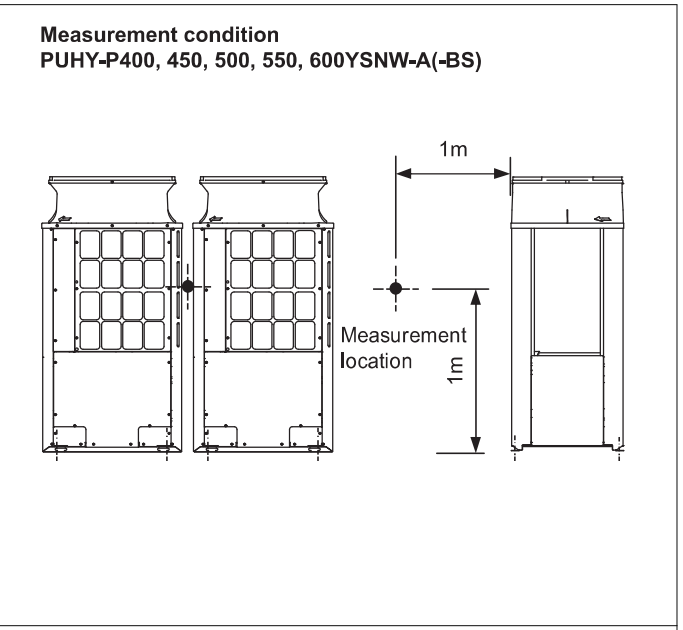
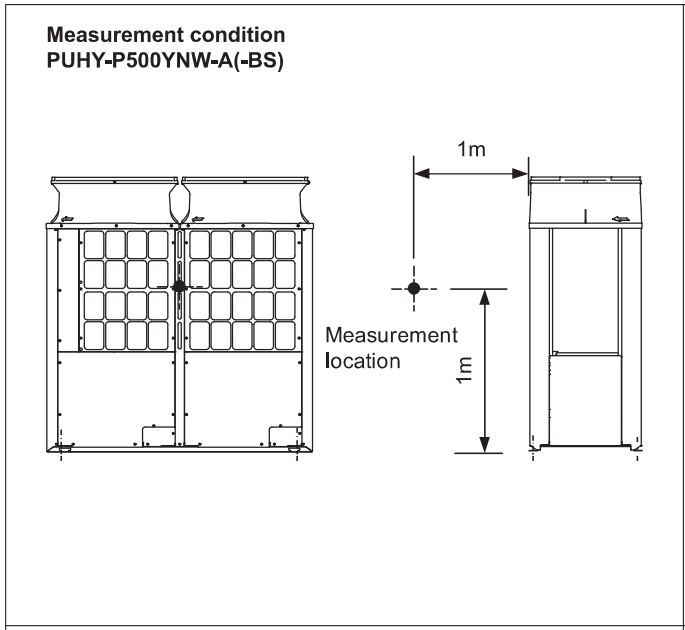

◆ Depending on the operation conditions, the unit generates noise caused by valve actuation, refrigerant flow, and pressure changes when operating normally. Please consider to avoid location where quietness is required.

Sound level of PUHY-P500YSNW-A(-BS)

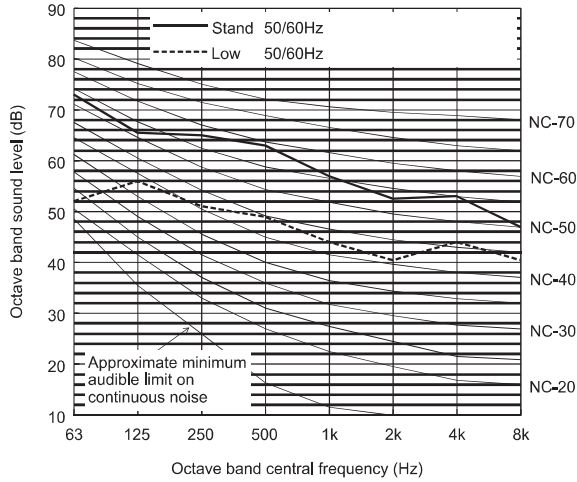

		63	125	250	500	1k	2k	4k	8k	dB(A)
Standard	50/60Hz	73.0	65.5	65.0	63.0	57.0	52.5	53.0	47.0	64.0
Low noise mode	50/60Hz	52.0	56.0	51.0	49.0	44.0	40.5	44.0	40.5	51.5

When Low noise mode is set, the A/C system's capacity is limited. The system could return to normal operation from Low noise mode automatically in the case that the operation condition is severe.

Measurement condition
PUHY-P650YSNW-A(-BS)

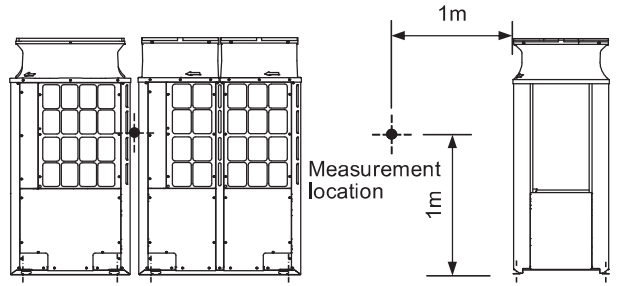

Sound level of PUHY-P550YSNW-A(-BS)

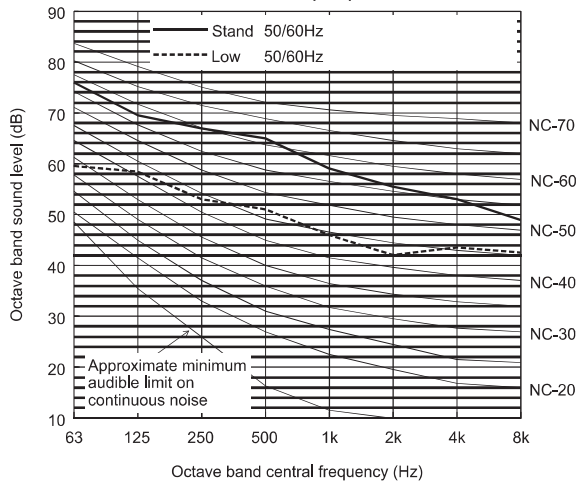

		63	125	250	500	1k	2k	4k	8k	dB(A)
Standard	50/60Hz	76.0	69.5	67.0	65.0	59.0	55.5	53.0	49.0	66.0
Low noise mode	50/60Hz	59.5	58.5	53.0	51.0	46.0	42.0	43.5	42.5	53.0

When Low noise mode is set, the A/C system's capacity is limited. The system could return to normal operation from Low noise mode automatically in the case that the operation condition is severe.

Sound level of PUHY-P650YSNW-A(-BS)

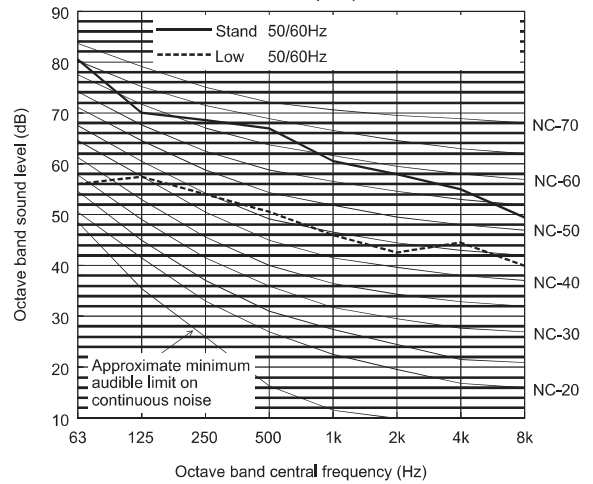

		63	125	250	500	1k	2k	4k	8k	dB(A)
Standard	50/60Hz	80.5	70.0	68.5	67.0	60.5	58.0	55.0	49.5	68.0
Low noise mode	50/60Hz	56.0	57.5	54.0	50.5	46.0	42.5	44.5	40.0	53.0

When Low noise mode is set, the A/C system's capacity is limited. The system could return to normal operation from Low noise mode automatically in the case that the operation condition is severe.

Sound level of PUHY-P600YSNW-A(-BS)

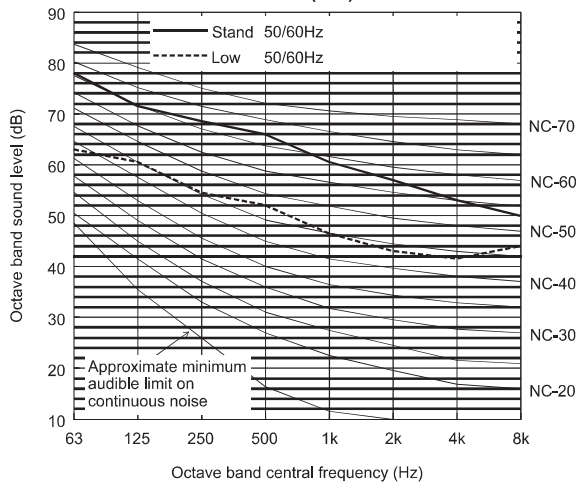

		63	125	250	500	1k	2k	4k	8k	dB(A)
Standard	50/60Hz	78.0	71.5	68.5	66.0	60.5	57.0	53.0	50.0	67.5
Low noise mode	50/60Hz	63.0	60.5	54.5	52.0	46.5	43.0	41.5	44.0	54.0

When Low noise mode is set, the A/C system's capacity is limited. The system could return to normal operation from Low noise mode automatically in the case that the operation condition is severe.

◆ Depending on the operation conditions, the unit generates noise caused by valve actuation, refrigerant flow, and pressure changes when operating normally. Please consider to avoid location where quietness is required.

PUHY-P-Y(S)NW-A

Measurement condition
PUHY-P700, 750, 800, 850, 900YSNW-A(-BS)

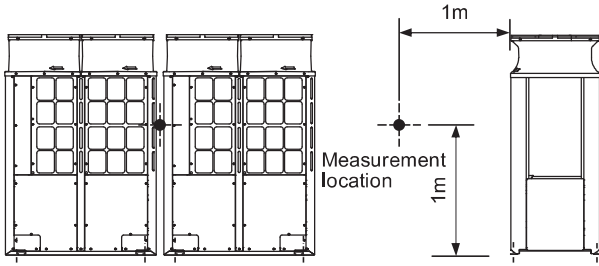

Sound level of PUHY-P800YSNW-A(-BS)

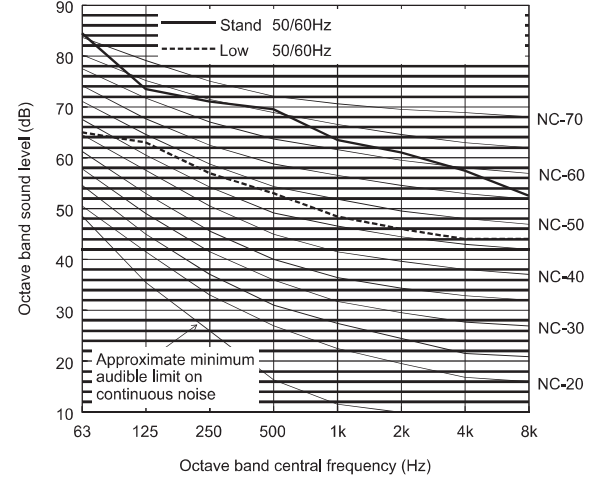

		63	125	250	500	1k	2k	4k	8k	dB(A)
Standard	50/60Hz	84.5	73.5	71.0	69.5	63.5	61.0	57.5	52.5	71.0
Low noise mode	50/60Hz	65.0	63.0	57.0	53.0	48.5	46.0	44.0	44.0	56.0

When Low noise mode is set, the A/C system's capacity is limited. The system could return to normal operation from Low noise mode automatically in the case that the operation condition is severe.

Sound level of PUHY-P700YSNW-A(-BS)

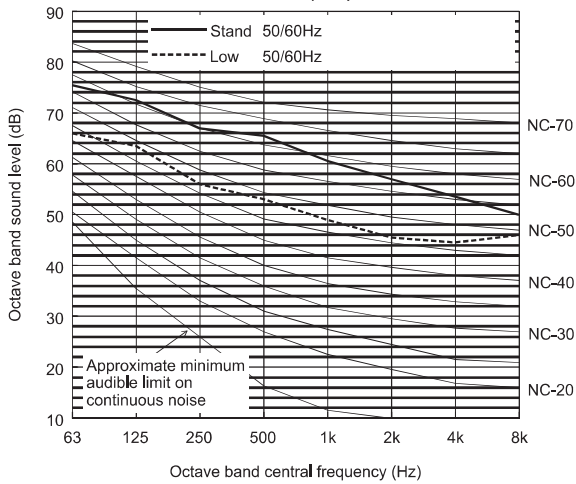

		63	125	250	500	1k	2k	4k	8k	dB(A)
Standard	50/60Hz	75.5	72.5	67.0	65.5	60.5	57.0	53.5	50.0	67.0
Low noise mode	50/60Hz	66.0	63.5	56.0	53.0	49.0	45.5	44.5	46.0	56.0

When Low noise mode is set, the A/C system's capacity is limited. The system could return to normal operation from Low noise mode automatically in the case that the operation condition is severe.

Sound level of PUHY-P850YSNW-A(-BS)

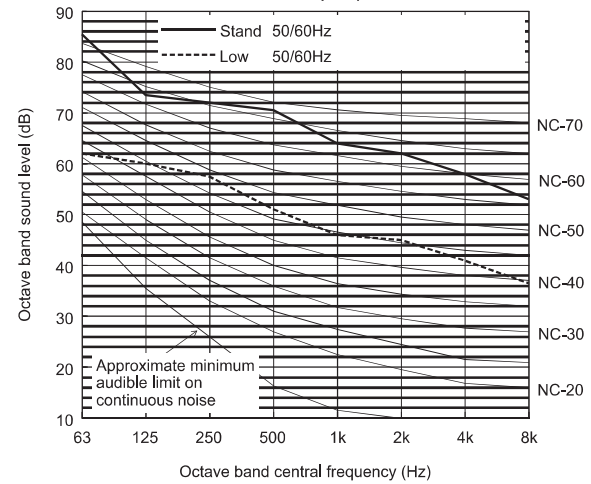

		63	125	250	500	1k	2k	4k	8k	dB(A)
Standard	50/60Hz	85.5	73.5	72.0	70.5	64.0	62.0	58.0	53.0	71.5
Low noise mode	50/60Hz	62.0	60.0	57.5	51.0	46.0	45.0	41.0	36.5	54.5

When Low noise mode is set, the A/C system's capacity is limited. The system could return to normal operation from Low noise mode automatically in the case that the operation condition is severe.

Sound level of PUHY-P750YSNW-A(-BS)

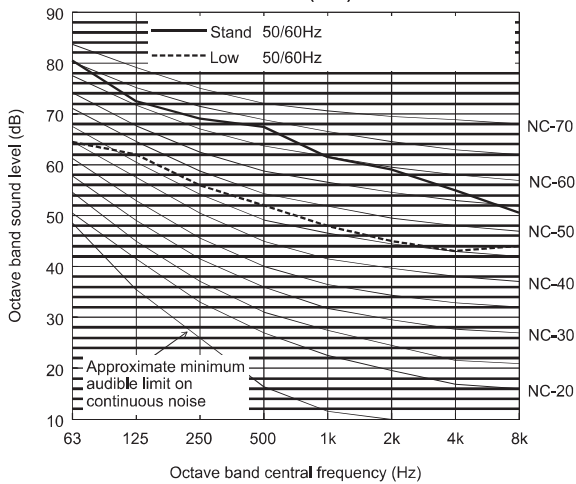

		63	125	250	500	1k	2k	4k	8k	dB(A)
Standard	50/60Hz	80.5	72.5	69.0	67.5	61.5	59.0	55.0	50.5	68.5
Low noise mode	50/60Hz	64.5	62.0	56.0	52.0	48.0	45.0	43.0	44.0	55.0

When Low noise mode is set, the A/C system's capacity is limited. The system could return to normal operation from Low noise mode automatically in the case that the operation condition is severe.

Sound level of PUHY-P900YSNW-A(-BS)

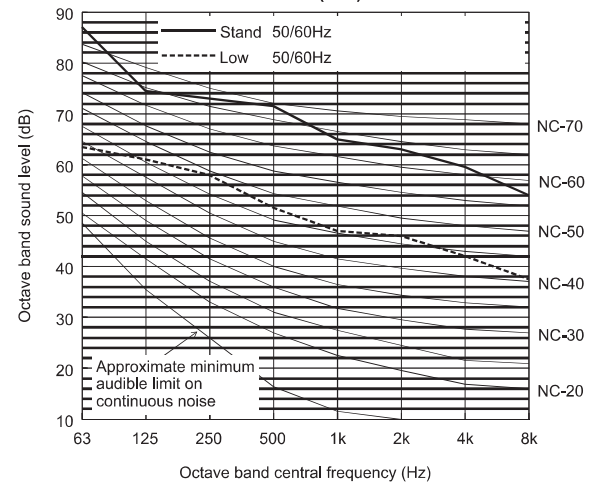

		63	125	250	500	1k	2k	4k	8k	dB(A)
Standard	50/60Hz	87.0	74.5	73.0	71.5	65.0	63.0	59.5	54.0	72.5
Low noise mode	50/60Hz	63.5	61.0	58.0	51.5	47.0	46.0	42.0	37.5	55.0

When Low noise mode is set, the A/C system's capacity is limited. The system could return to normal operation from Low noise mode automatically in the case that the operation condition is severe.

♦ Depending on the operation conditions, the unit generates noise caused by valve actuation, refrigerant flow, and pressure changes when operating normally. Please consider to avoid location where quietness is required.

Measurement condition
PUHY-P950, 1000, 1050YSNW-A(-BS)

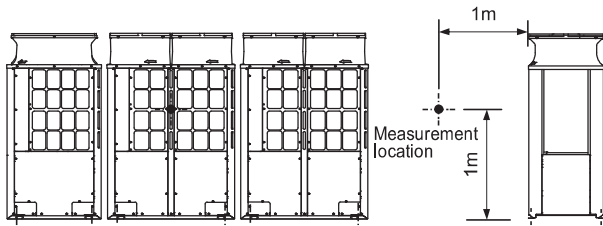

Sound level of PUHY-P1050YSNW-A(-BS)

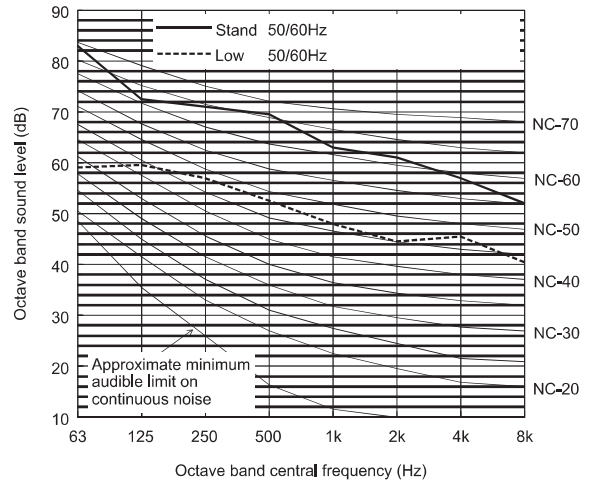

		63	125	250	500	1k	2k	4k	8k	dB(A)
Standard	50/60Hz	83.0	72.5	71.0	69.5	63.0	61.0	57.0	52.0	70.5
Low noise mode	50/60Hz	59.0	59.5	57.0	52.5	48.0	44.5	45.5	40.5	55.0

When Low noise mode is set, the A/C system's capacity is limited. The system could return to normal operation from Low noise mode automatically in the case that the operation condition is severe.

Sound level of PUHY-P950YSNW-A(-BS)

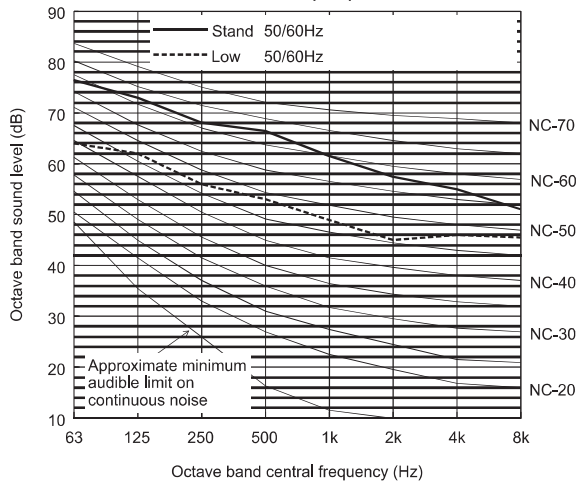

		63	125	250	500	1k	2k	4k	8k	dB(A)
Standard	50/60Hz	76.5	73.0	68.0	66.5	61.5	57.5	55.0	51.0	68.0
Low noise mode	50/60Hz	64.0	62.0	56.0	53.0	49.0	45.0	46.0	45.5	56.0

When Low noise mode is set, the A/C system's capacity is limited. The system could return to normal operation from Low noise mode automatically in the case that the operation condition is severe.

Sound level of PUHY-P1000YSNW-A(-BS)

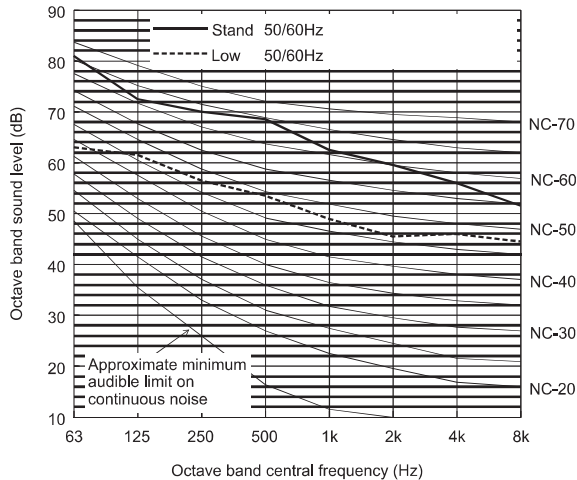

		63	125	250	500	1k	2k	4k	8k	dB(A)
Standard	50/60Hz	81.0	72.5	70.0	68.5	62.5	59.5	56.0	51.5	69.5
Low noise mode	50/60Hz	63.0	61.5	56.5	53.5	49.0	45.5	46.0	44.5	56.0

When Low noise mode is set, the A/C system's capacity is limited. The system could return to normal operation from Low noise mode automatically in the case that the operation condition is severe.

◆ Depending on the operation conditions, the unit generates noise caused by valve actuation, refrigerant flow, and pressure changes when operating normally. Please consider to avoid location where quietness is required.

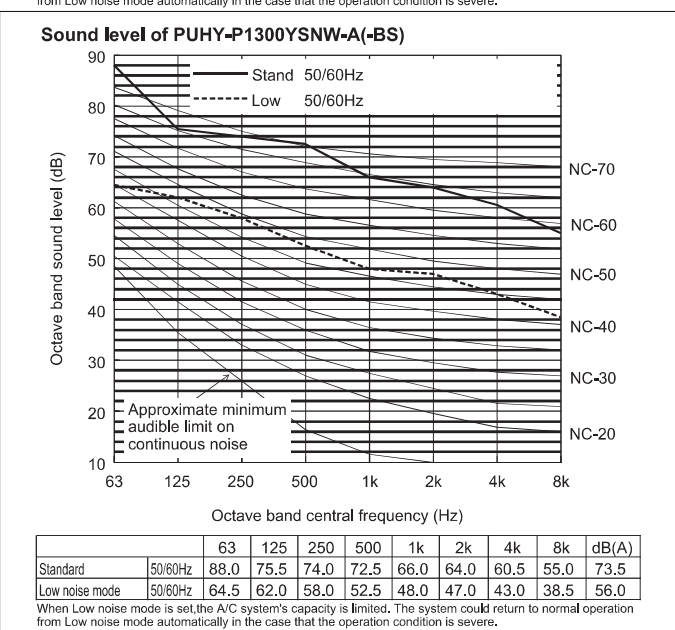
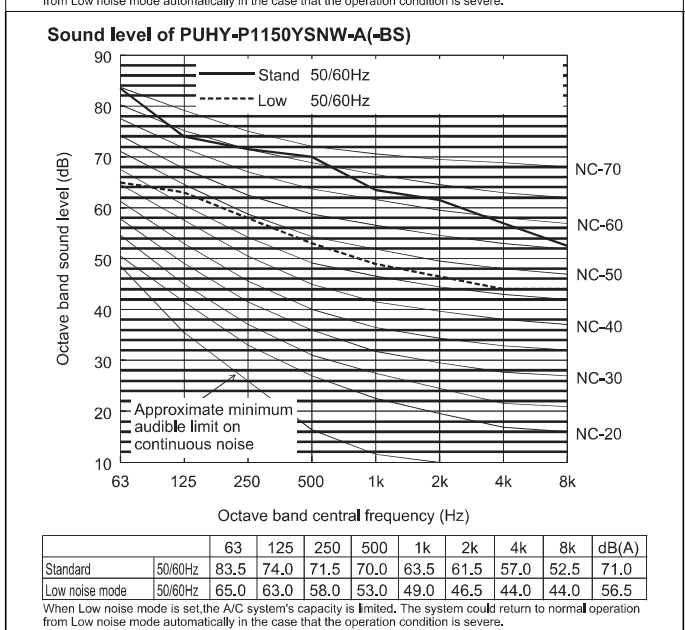
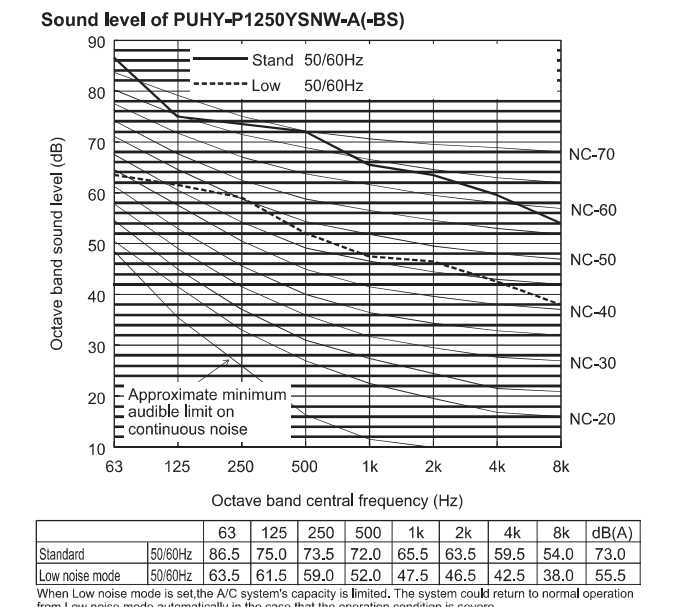
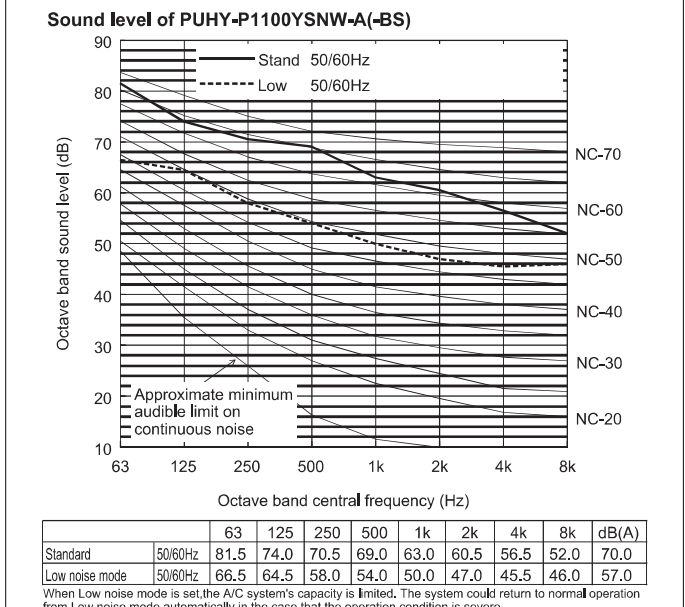
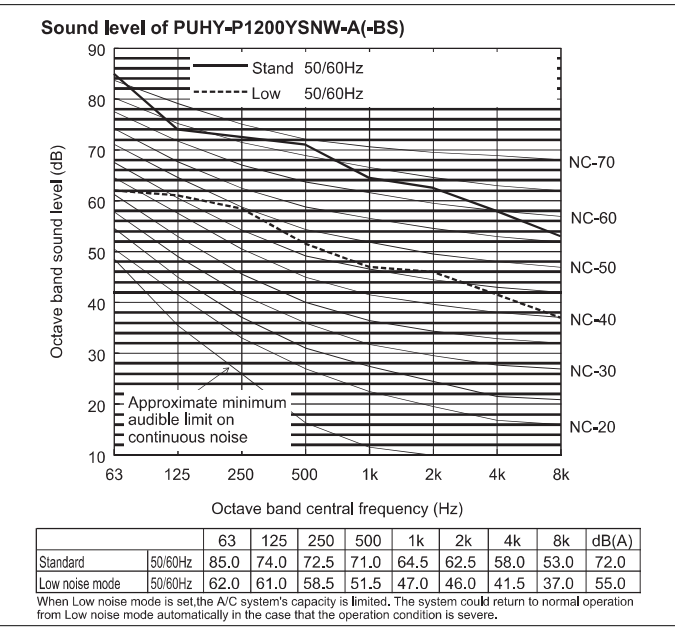
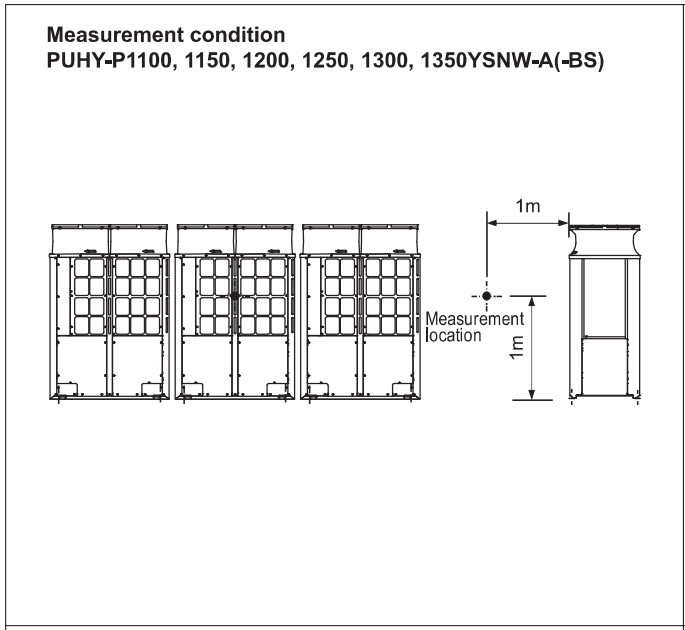

♦ Depending on the operation conditions, the unit generates noise caused by valve actuation, refrigerant flow, and pressure changes when operating normally. Please consider to avoid location where quietness is required.

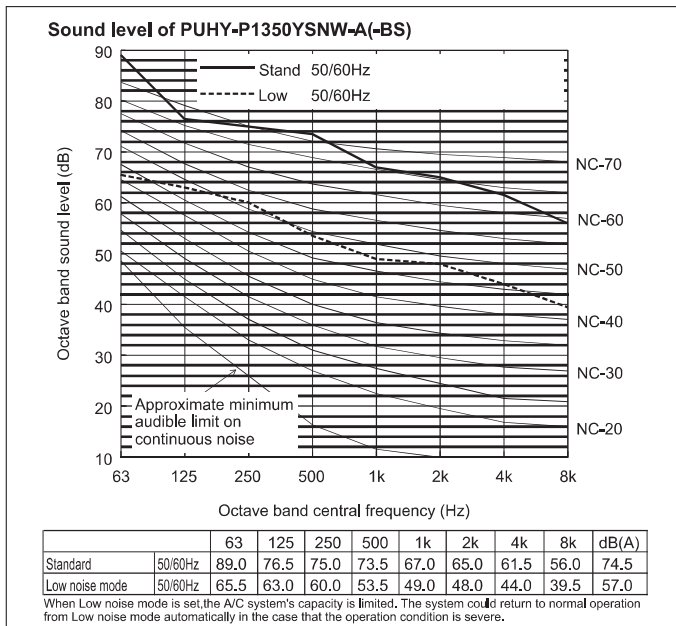

- ◆ Depending on the operation conditions, the unit generates noise caused by valve actuation, refrigerant flow, and pressure changes when operating normally. Please consider to avoid location where quietness is required.